

BACKRESTS BEK

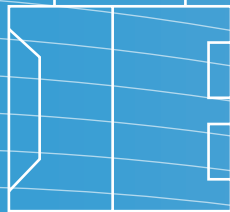

BUDDY BRACE



BEK SHIFT

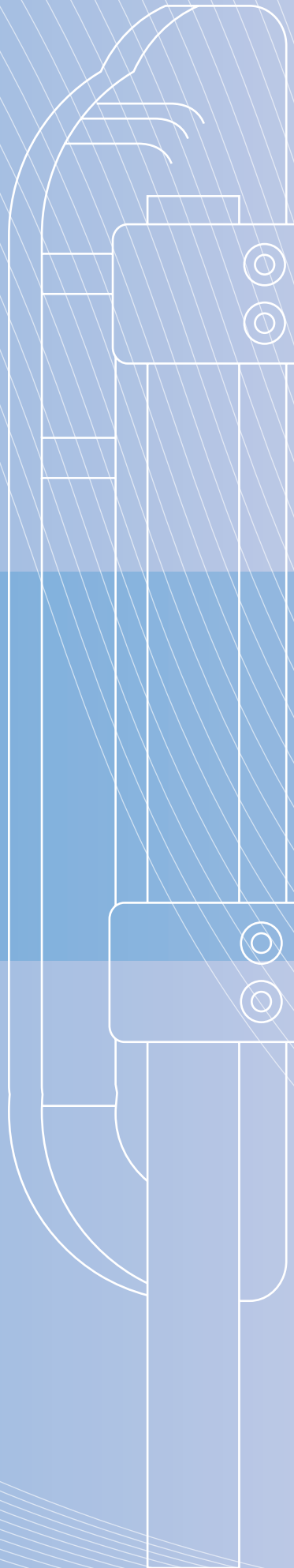



Covers	User weight	Backrest width	Backrest height	Warranty	Crash tested	Certificates	Fire resistant
Seamless and breathable	Max 150 kg	from 26 to 54	from 30 to 55	2 years	On manual and powered wheelchairs		TÜV Rheinland Accredited Laboratory



- 1 Postural backrest highly adjustable
- 2 Freedom of movement with adjustable side supports
- 3 Comfortable customizable padding and breathable cover

SIZES

Bek	Wheelchair width	Backrest width (A)	Backrest height (B)
	24 - 28 cm	26 cm (M0)	30 cm
	26 - 30 cm	30 cm (M1)	35 cm - 40 cm
	30 - 34 cm	34 cm (M2)	40 cm - 45 cm
	34 - 38 cm	38 cm (M3)	45 cm - 50 cm
	38 - 42 cm	42 cm (M4)	45 cm - 50 cm - 55 cm
	42 - 46 cm	46 cm (M5)	45 cm - 50 cm - 55 cm
	46 - 50 cm	50 cm (M6)	55 cm
	48 - 52 cm	54 cm (M7)	50 cm

COVERS

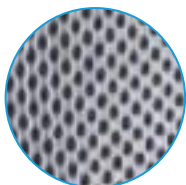

BREATHABLE
BACK SIDE



ANTISLIP
BACK SIDE



BREATHABLE
PART OF CONTACT



PADDINGS

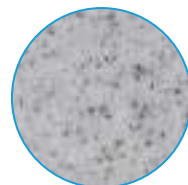

MEMORY



BREATHABLE

MOUNTING SYSTEMS



ADJUSTABLE
SEPARATE CLAMPS



ADJUSTABLE
UNIQUE CLAMPS



2 cm

2,2 cm

2,5 cm



SUPPORT

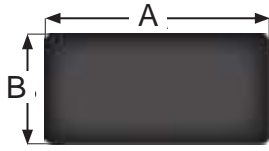

PAD SIZES

	S	M	L
A	11,0 cm	14,0 cm	18,0 cm
B	9,0 cm	10,0 cm	12,0 cm



ADJUSTMENTS

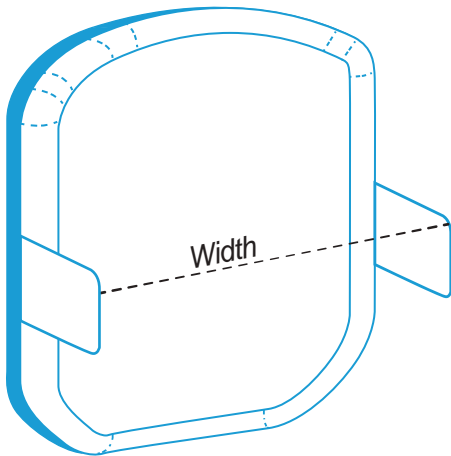

Backrest width	Width with Pad S		Width with Pad M/L	
	min.	max.	min.	max.
M0 (26 cm)	12,0 cm	25,5 cm	10,5 cm	24,0 cm
M1 (30 cm)	16,5 cm	30,0 cm	15,0 cm	28,5 cm
M2 (34 cm)	20,5 cm	34,0 cm	19,0 cm	32,5 cm
M3 (38 cm)	24,5 cm	38,0 cm	23,0 cm	36,5 cm
M4 (42 cm)	28,5 cm	42,0 cm	27,0 cm	40,5 cm
M5 (46 cm)	32,5 cm	46,0 cm	31,0 cm	44,0 cm
M6 (50 cm)	36,5 cm	50,0 cm	35,0 cm	48,5 cm
M7 (54 cm)	40,5 cm	54,0 cm	39,0 cm	52,5 cm

MOUNTING SYSTEMS

FIXED

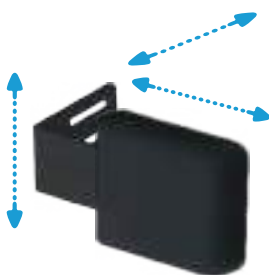

← ADJUSTMENTS →

SWING-AWAY

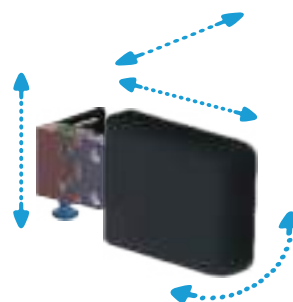

← ADJUSTMENTS →

DETACHABLE

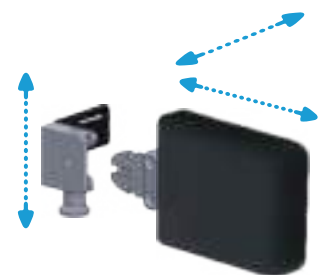

← ADJUSTMENTS →

HUG

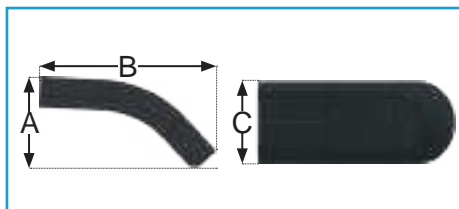

PAD SIZES			
	S	M	L
A	5,5 cm	10,0 cm	10,0 cm
B	12,0 cm	18,0 cm	24,0 cm
C	9,0 cm	9,0 cm	10,0 cm



ADJUSTMENTS

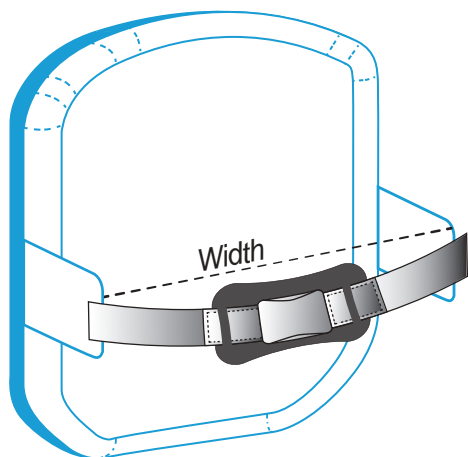

Backrest width	Width with Pad S		Width with Pad M/L	
	min.	max.	min.	max.
M0 (26 cm)	12,0 cm	25,5 cm	10,5 cm	24,0 cm
M1 (30 cm)	16,5 cm	30,0 cm	15,0 cm	28,5 cm
M2 (34 cm)	20,5 cm	34,0 cm	19,0 cm	32,5 cm
M3 (38 cm)	24,5 cm	38,0 cm	23,0 cm	36,5 cm
M4 (42 cm)	28,5 cm	42,0 cm	27,0 cm	40,5 cm
M5 (46 cm)	32,5 cm	46,0 cm	31,0 cm	44,0 cm
M6 (50 cm)	36,5 cm	50,0 cm	35,0 cm	48,5 cm
M7 (54 cm)	40,5 cm	54,0 cm	39,0 cm	52,5 cm

MOUNTING SYSTEMS

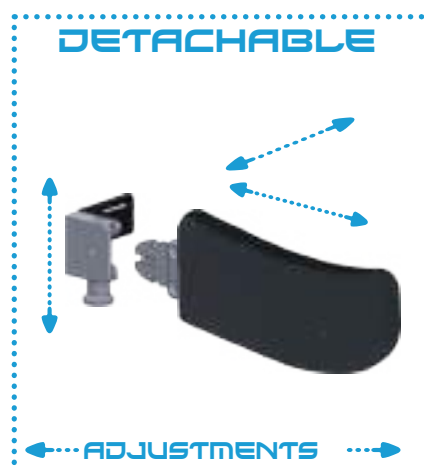



CONTOUR

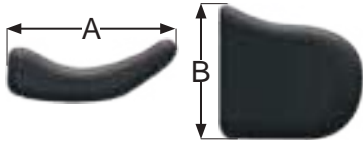

PAD SIZES			
	S	M	L
A	11,0 cm	15,0 cm	20,0 cm
B	8,0 cm	15,0 cm	20,0 cm



ADJUSTMENTS

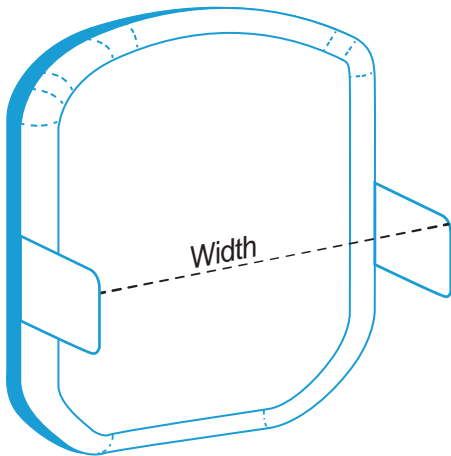

Backrest width	Width with Pad S		Width with Pad M/L	
	min.	max.	min.	max.
M0 (26 cm)	12,0 cm	25,5 cm	10,5 cm	24,0 cm
M1 (30 cm)	16,5 cm	30,0 cm	15,0 cm	28,5 cm
M2 (34 cm)	20,5 cm	34,0 cm	19,0 cm	32,5 cm
M3 (38 cm)	24,5 cm	38,0 cm	23,0 cm	36,5 cm
M4 (42 cm)	28,5 cm	42,0 cm	27,0 cm	40,5 cm
M5 (46 cm)	32,5 cm	46,0 cm	31,0 cm	44,0 cm
M6 (50 cm)	36,5 cm	50,0 cm	35,0 cm	48,5 cm
M7 (54 cm)	40,5 cm	54,0 cm	39,0 cm	52,5 cm

MOUNTING SYSTEMS

FIXED

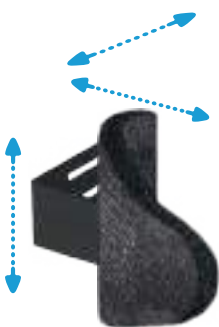

ADJUSTMENTS

SWING-AWAY

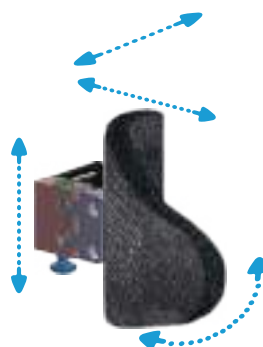

ADJUSTMENTS

DETACHABLE

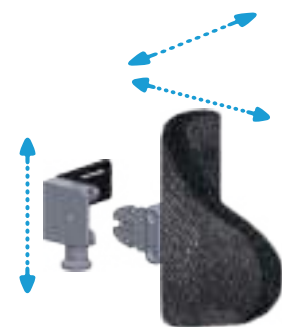

ADJUSTMENTS

HOLD UP

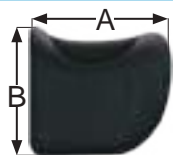

PAD SIZES

	S	M	L
A	12,0 cm	16,0 cm	21,0 cm
B	9,0 cm	16,0 cm	21,0 cm

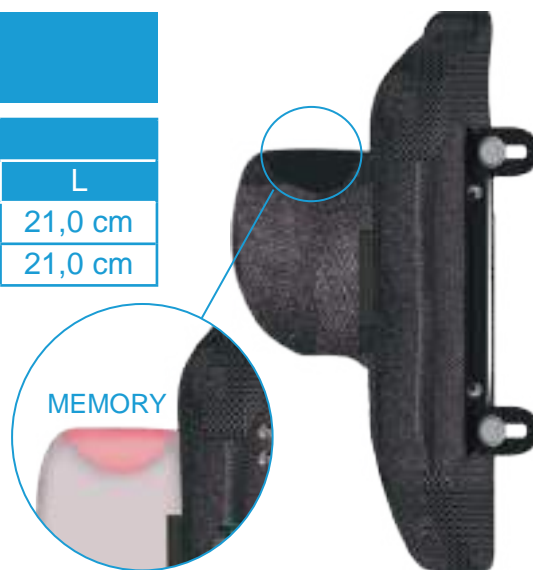

ADJUSTMENTS

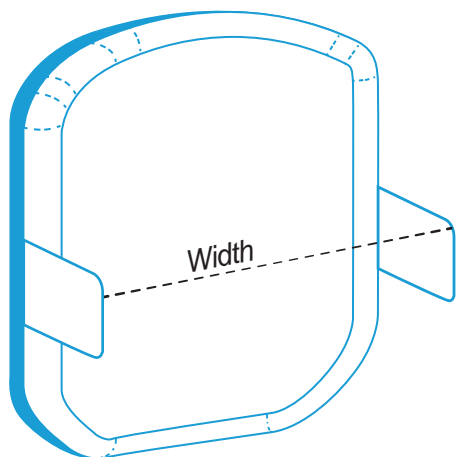

Backrest width	Width with Pad S		Width with Pad M/L	
	min.	max.	min.	max.
M0 (26 cm)	12,0 cm	25,5 cm	10,5 cm	24,0 cm
M1 (30 cm)	16,5 cm	30,0 cm	15,0 cm	28,5 cm
M2 (34 cm)	20,5 cm	34,0 cm	19,0 cm	32,5 cm
M3 (38 cm)	24,5 cm	38,0 cm	23,0 cm	36,5 cm
M4 (42 cm)	28,5 cm	42,0 cm	27,0 cm	40,5 cm
M5 (46 cm)	32,5 cm	46,0 cm	31,0 cm	44,0 cm
M6 (50 cm)	36,5 cm	50,0 cm	35,0 cm	48,5 cm
M7 (54 cm)	40,5 cm	54,0 cm	39,0 cm	52,5 cm

MOUNTING SYSTEMS

FIXED



ADJUSTMENTS

SWING-AWAY



ADJUSTMENTS

DETACHABLE

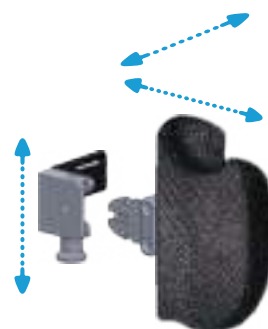

ADJUSTMENTS



BUDDY BRACE

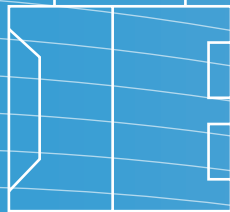

BEK ROUND





BEK ROUND

BACKRESTS

Covers	User weight	Backrest width	Backrest height	Warranty	Crash tested	Certificates	Fire resistant
Seamless and breathable	Max 150 kg	from 26 to 54	from 30 to 55	2 years	On manual and powered wheelchairs		TÜV Rheinland Accredited Laboratory



1 Comfortable backrest suitable for people with poor trunk control

2 Adjustments in height and width of the lateral containment

3 Comfortable customizable padding and breathable cover

SIZES

Bek	Wheelchair width	Backrest width (A)	Backrest height (B)
	24 - 28 cm	26 cm (M0)	30 cm
	26 - 30 cm	30 cm (M1)	35 cm - 40 cm
	30 - 34 cm	34 cm (M2)	40 cm - 45 cm
	34 - 38 cm	38 cm (M3)	45 cm - 50 cm
	38 - 42 cm	42 cm (M4)	45 cm - 50 cm - 55 cm
	42 - 46 cm	46 cm (M5)	45 cm - 50 cm - 55 cm
	46 - 50 cm	50 cm (M6)	55 cm
	48 - 52 cm	54 cm (M7)	50 cm

COVERS

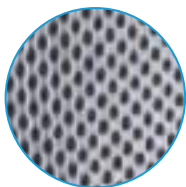

BREATHABLE
BACK SIDE



ANTISLIP
BACK SIDE



BREATHABLE
PART OF CONTACT



PADDINGS



BREATHABLE

MOUNTING SYSTEMS



ADJUSTABLE
SEPARATE CLAMPS



ADJUSTABLE
UNIQUE CLAMPS



2 cm

2,2 cm

2,5 cm

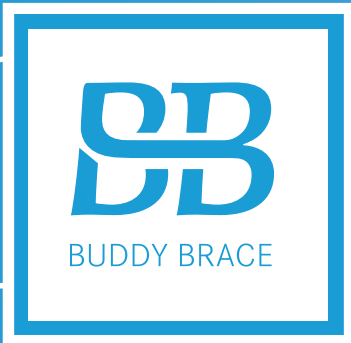

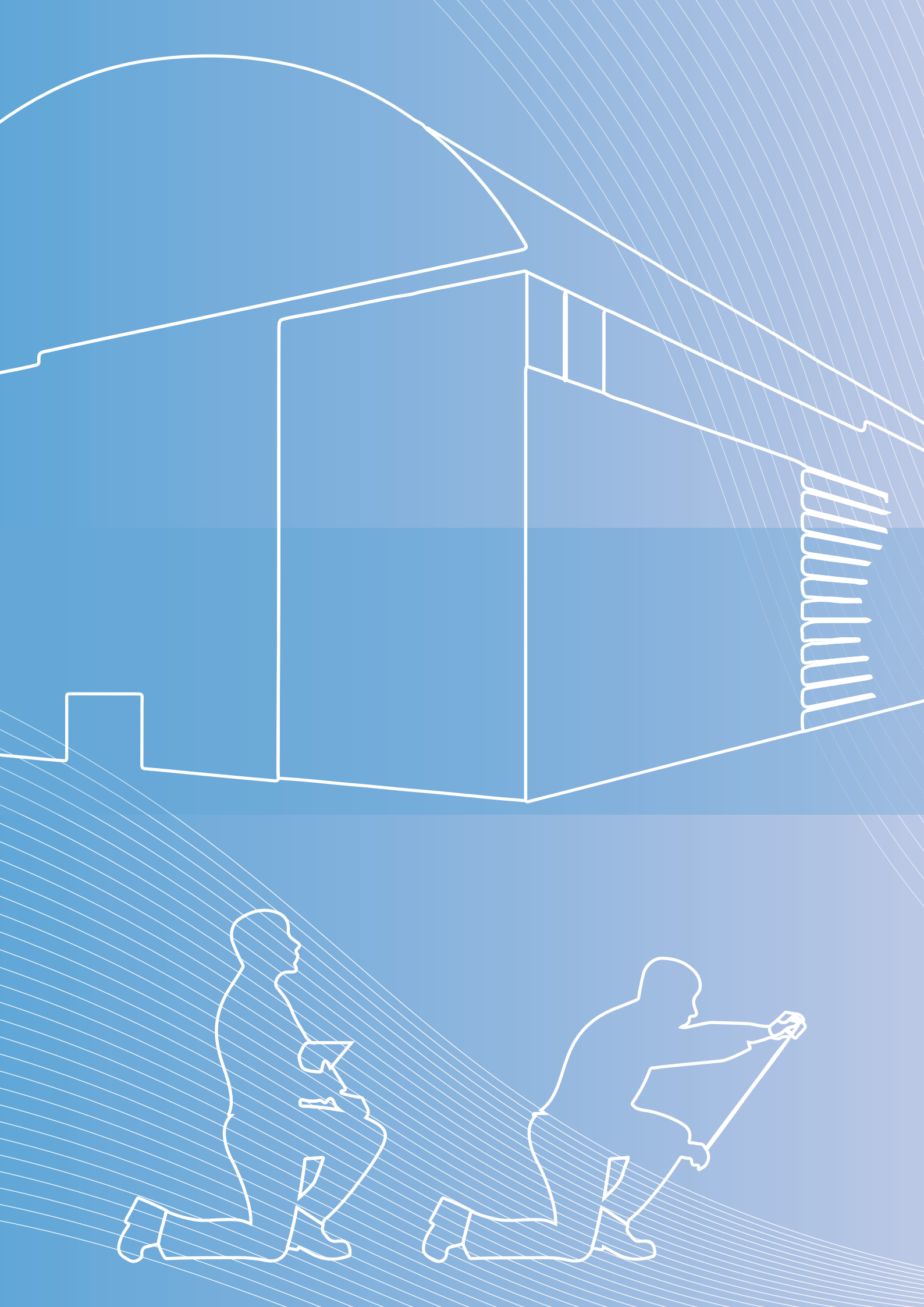



BUDDY BRACE

BUDDY BRACE

Via A. De Curtis 4/a
80040 Cercola (NA) ITALIA

tel 081 555.19.46

fax 081 555.25.07

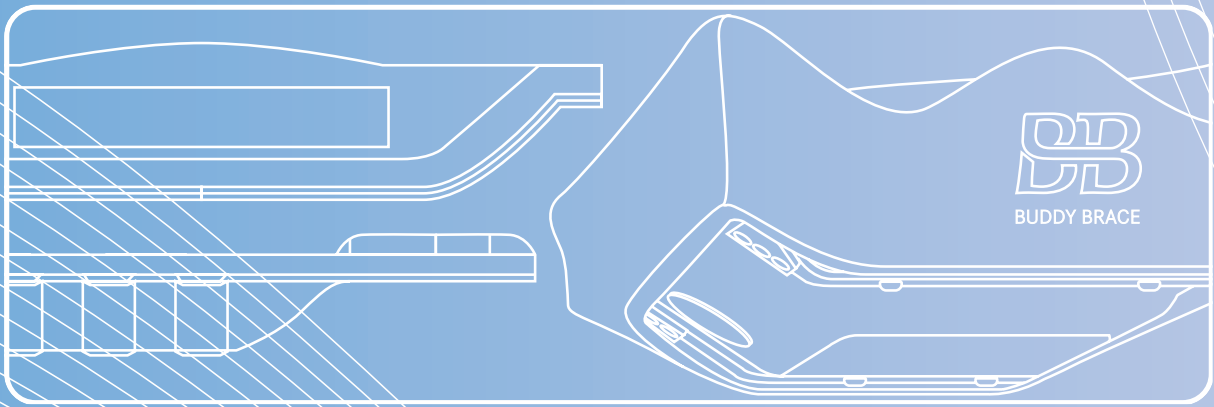
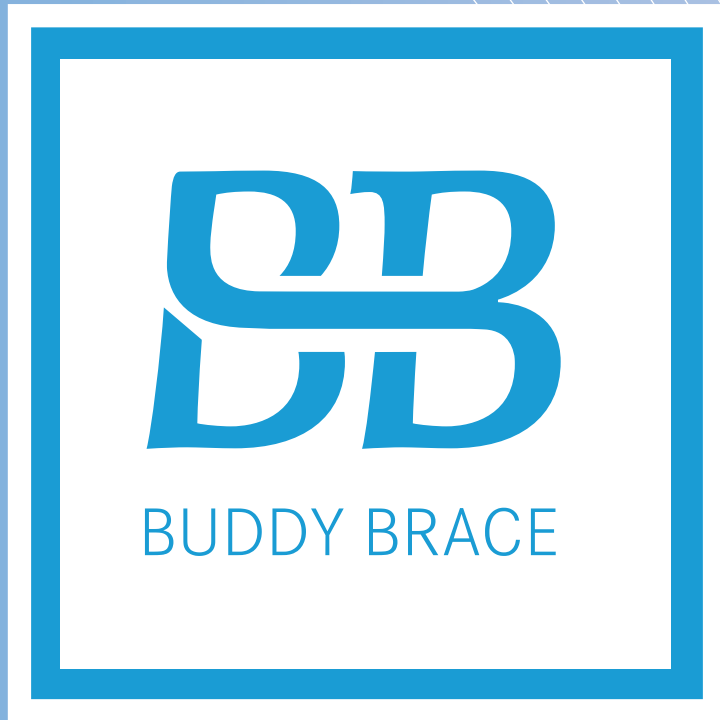

SEATS

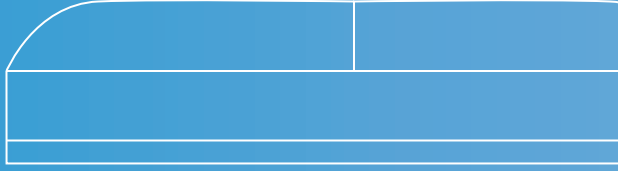
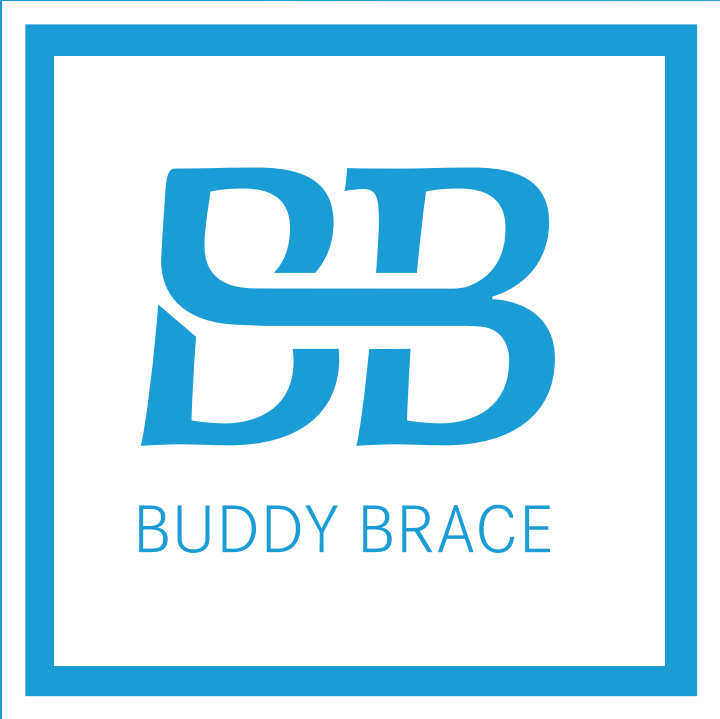

DYNAMIC



Covers	User weight	Seat width	Seat depth	Warranty	Crash tested	Certificates
<p>Seamless and breathable</p>	<p>Max 150 kg</p>	<p>← cm → from 30 to 46</p>	<p>↖ cm ↘ from 42 to 56</p>	<p>2 years</p>	<p>On manual and powered wheelchairs</p>	



SIZES

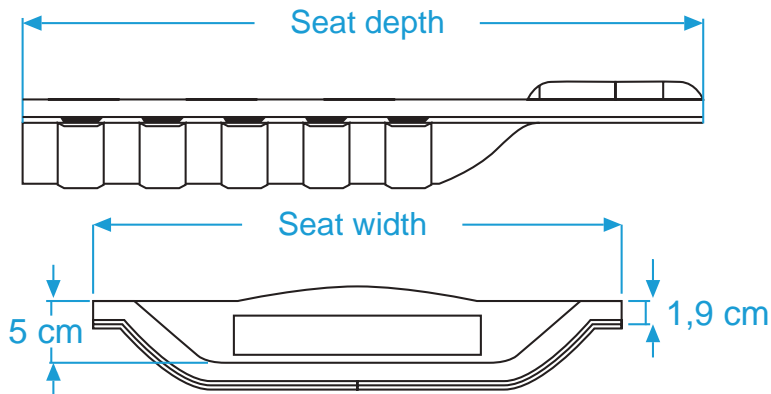

Wheelchair width	Seat width	Seat depth
30 - 32 cm	30 cm (M1)	42 cm
34 - 36 cm	34 cm (M2)	46 cm
38 - 40 cm	38 cm (M3)	50 cm
42 - 44 cm	42 cm (M4)	52 cm
46 - 48 cm	46 cm (M5)	56 cm

MOUNTING SYSTEM



SEATING SYSTEM BASED ON MODULAR INSERTS



PADDING IN MEMORY WITH NON-SLIP, TWO-WAY STRETCH AND BREATHABLE COVER

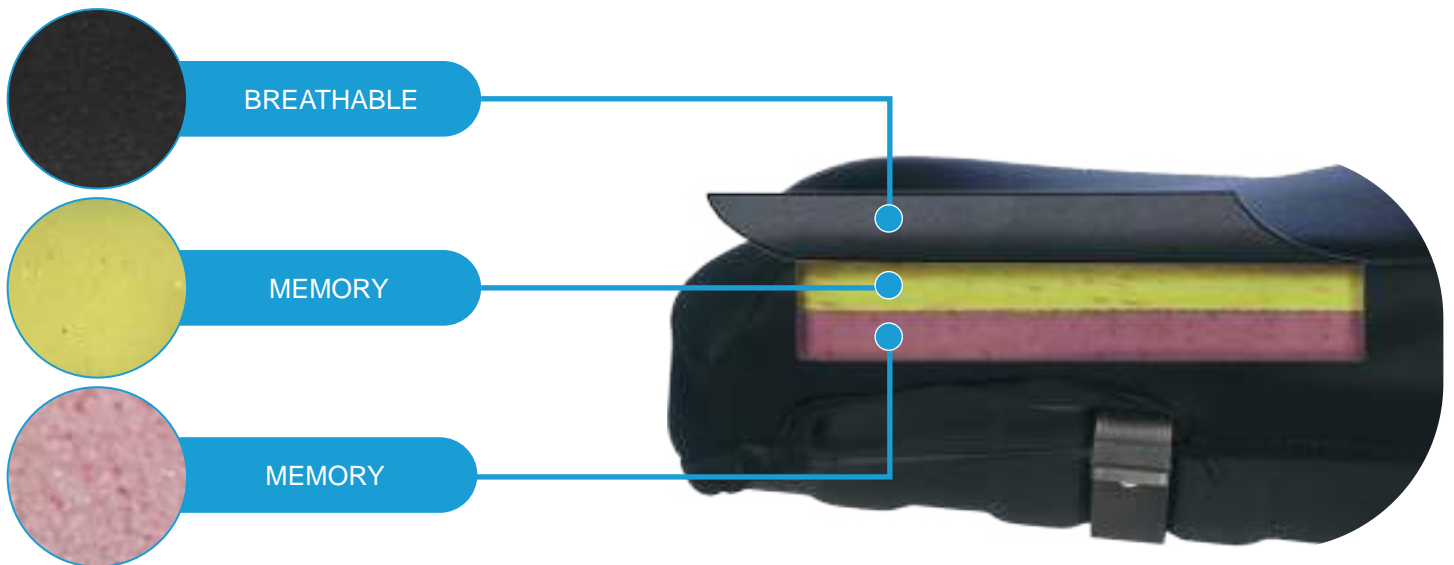

LOWERED RIGID AND NON-DEFORMABLE BASE

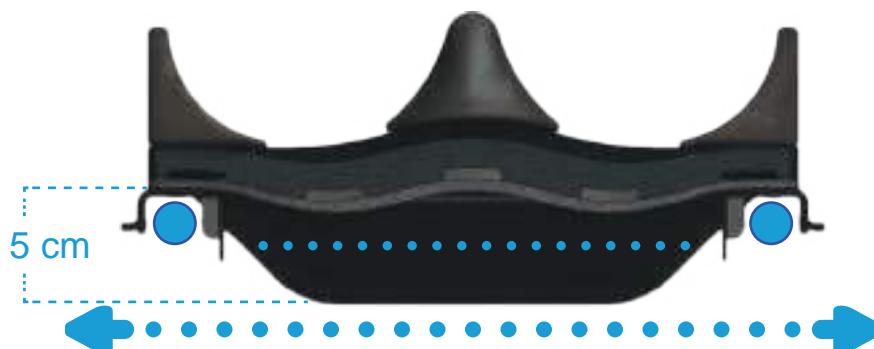

MODULAR INSERTS

INSERT FOR DEPTH REDUCTION



LATERAL CONTAINING



ADDUCTOR AND ABDUCTOR LEG INSERTS



IDEAL POSTURE



CLINICAL CASES AND PERSONALIZATION EXAMPLES

PELVIC ROTATION

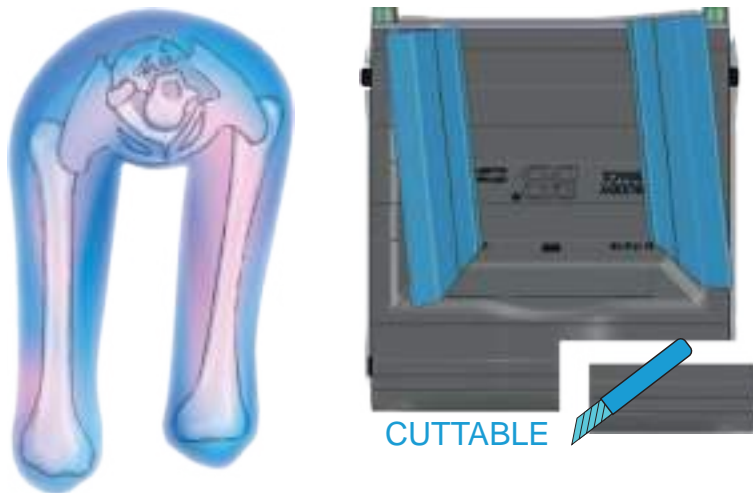

PELVIC OBLIQUITY

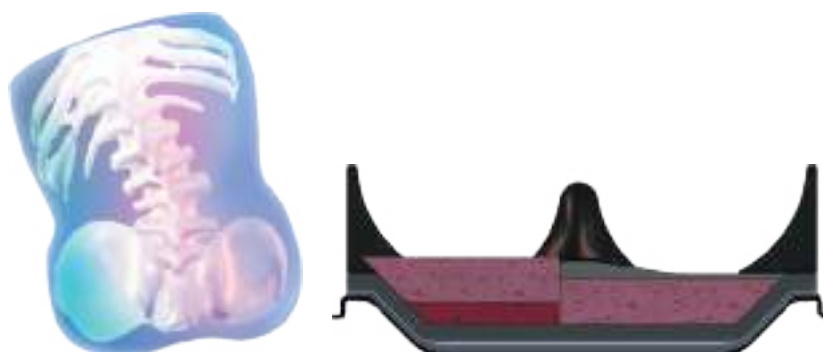



BUDDY BRACE



PEEZY





 Cuttable	Covers	User weight	Seat width	Seat depth	Warranty	Crash tested	Certificates	Fire resistant
	 Seamless Breathable Waterproof	 Max 150 kg	← cm → from 26 to 48	← cm → from 30 to 52	2 years	 On manual and powered wheelchairs		 Accredited Laboratory



SIZES

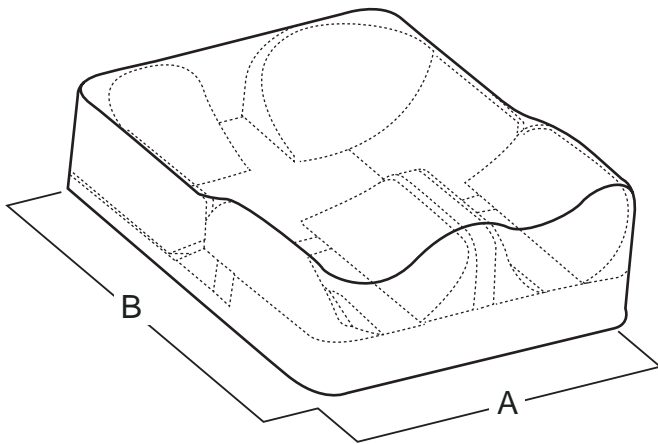

Peezy sizes	A	B
P1	26 cm	30 cm
P2	30 cm	34 cm
P3	30 cm	40 cm
P4	34 cm	44 cm
P5	36 cm	44 cm
P6	38 cm	48 cm
P7	42 cm	44 cm
P8	42 cm	52 cm
P9	44 cm	50 cm
P10	48 cm	52 cm

MOUNTING SYSTEMS



HIGHLY MODULAR TO ACCOMODATE SEVERE DEFORMITIES

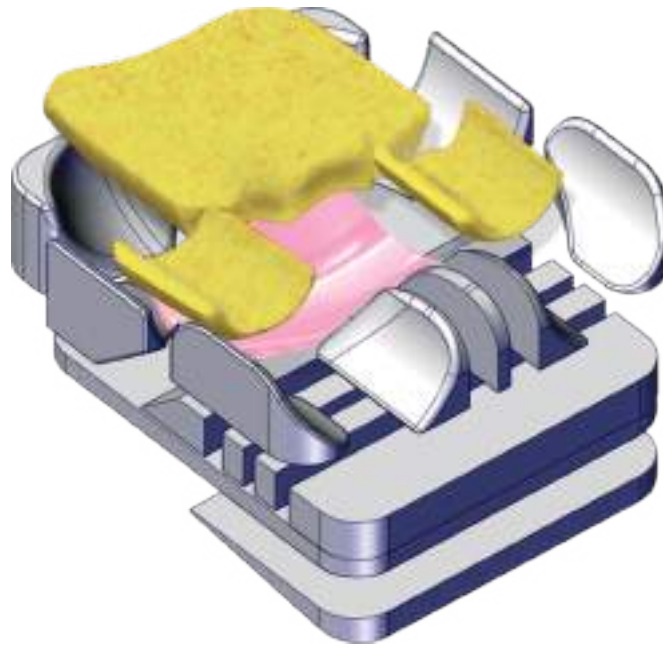

PADDING IN MEMORY WITH NON-SLIP, TWO-WAY STRETCH AND BREATHABLE COVER

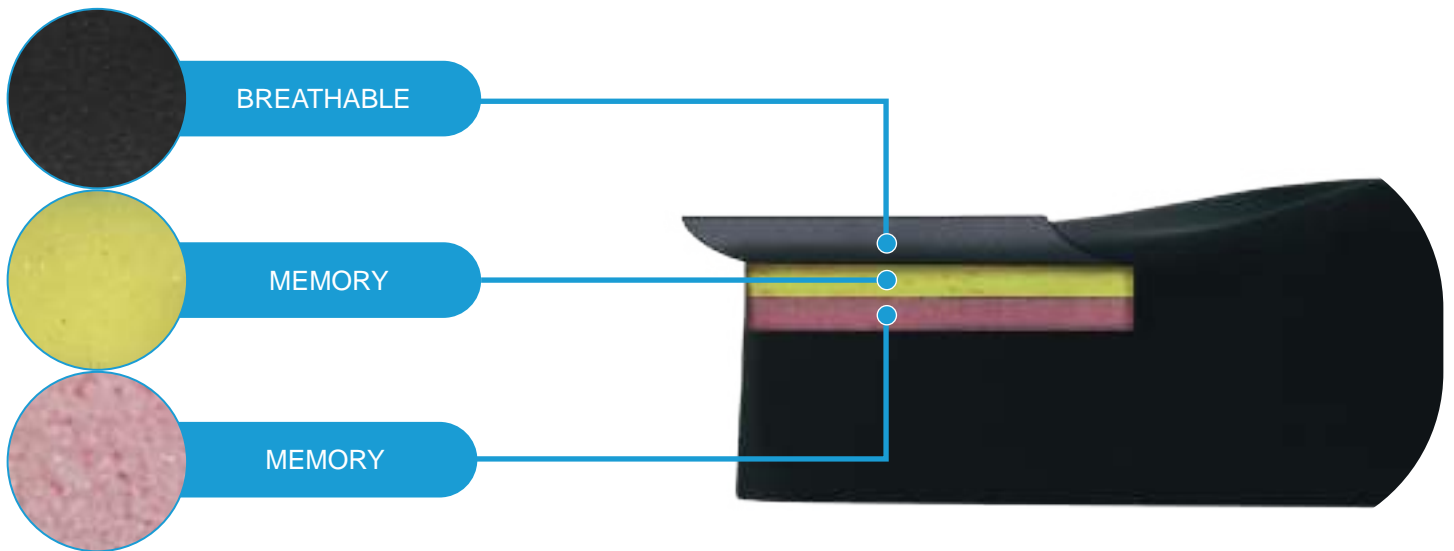

POSTURAL SEAT WITH FLAT BASE





MODULAR INSERTS

PELVIC CONTAINING INSERTS

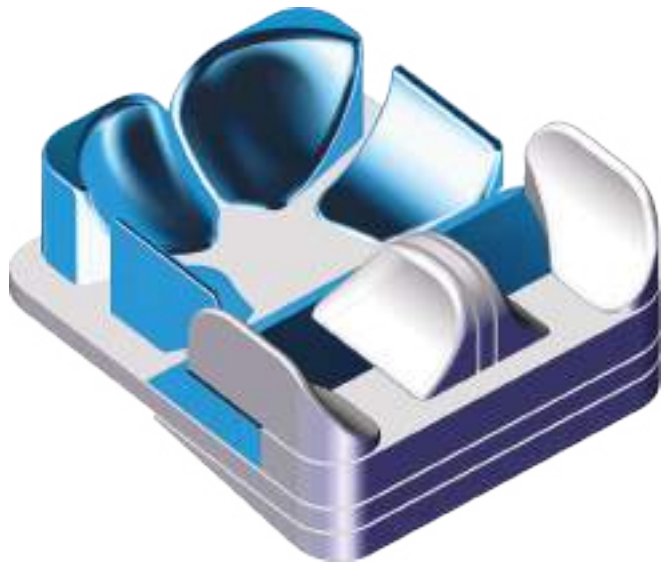

PELVIC CONTAINING AND LEG ABDUCTION INSERTS



DEPTH REDUCTION INSERTS

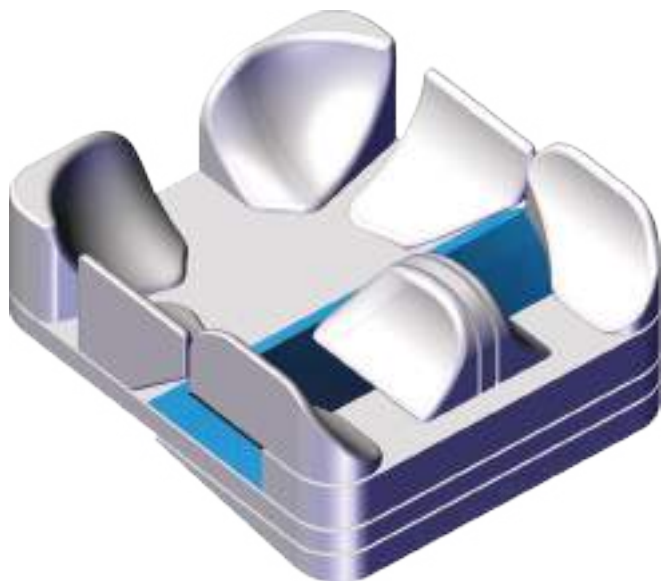

ABDUCTOR AND ADDUCTOR LEG INSERTS

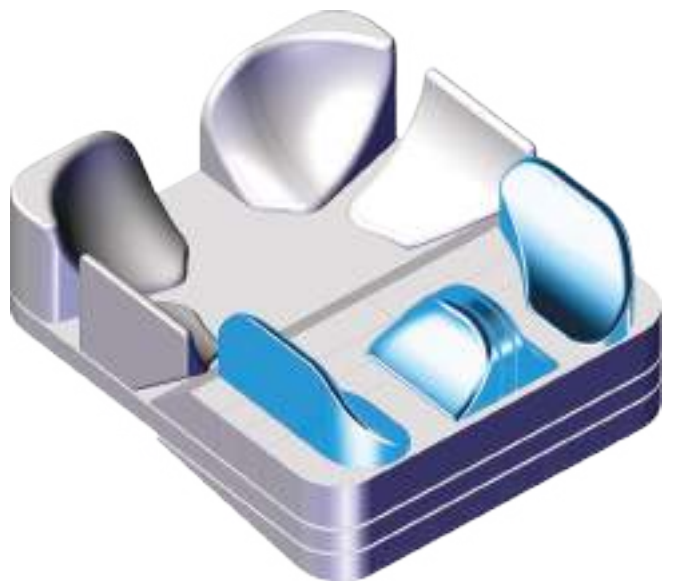

CLINICAL CASES AND PERSONALIZATION EXAMPLES

FIXED ABDUCTION

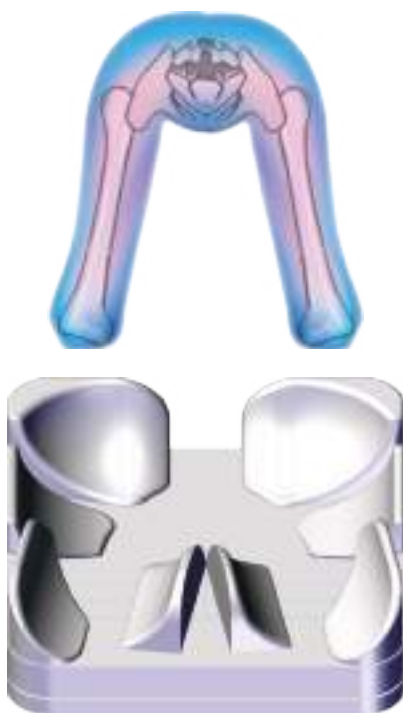

WIND SWEEP

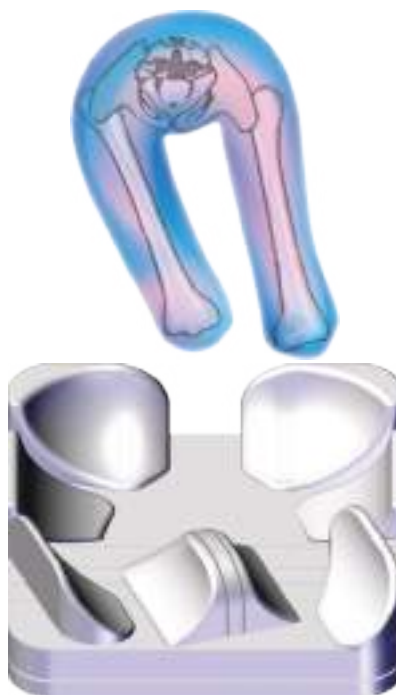

ASIMMETRY



PELVIC OBLIQUITY



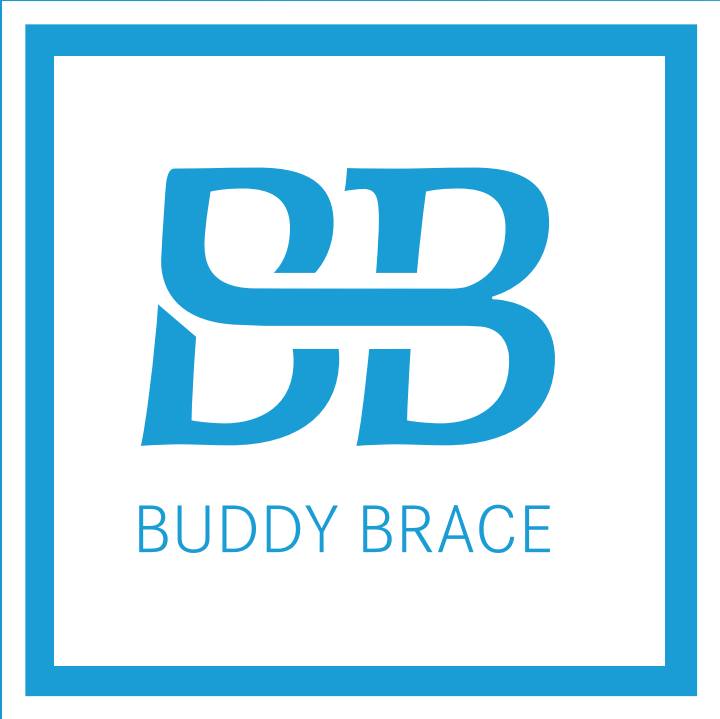

PEEZY LIGHT





PEEZY LIGHT

SEATS

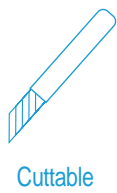

Covers Seamless Breathable Waterproof	User weight Max 150 kg	Seat width ← cm → from 26 to 48	Seat depth ← cm → from 30 to 52	Warranty 2 years	Crash tested On manual and powered wheelchairs	Certificates CE	Fire resistant TÜV Rheinland Accredited Laboratory
---	-------------------------------------	--	--	--------------------------------------	--	---------------------------	---



SIZES

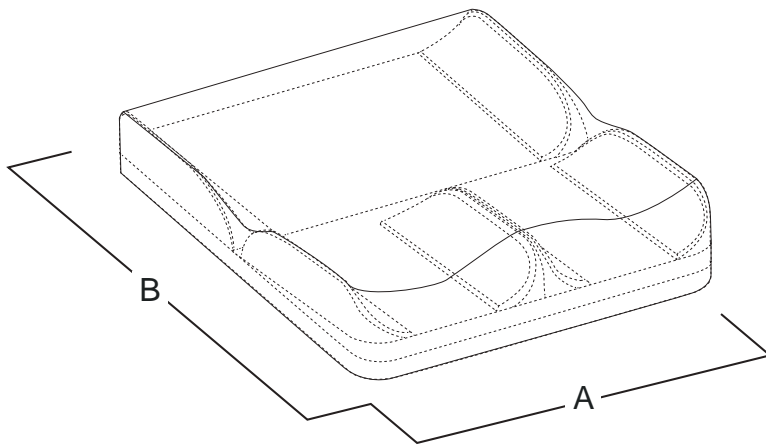

Peezy sizes	A	B
P1	26 cm	30 cm
P2	30 cm	34 cm
P3	30 cm	40 cm
P4	34 cm	44 cm
P5	36 cm	44 cm
P6	38 cm	48 cm
P7	42 cm	44 cm
P8	42 cm	52 cm
P9	44 cm	50 cm
P10	48 cm	52 cm

MOUNTING SYSTEMS



ANATOMICAL DESIGN TO ACCOMMODATE LIGHT DEFORMITIES



PADDING IN MEMORY WITH NON-SLIP, TWO-WAY STRETCH AND BREATHABLE COVER

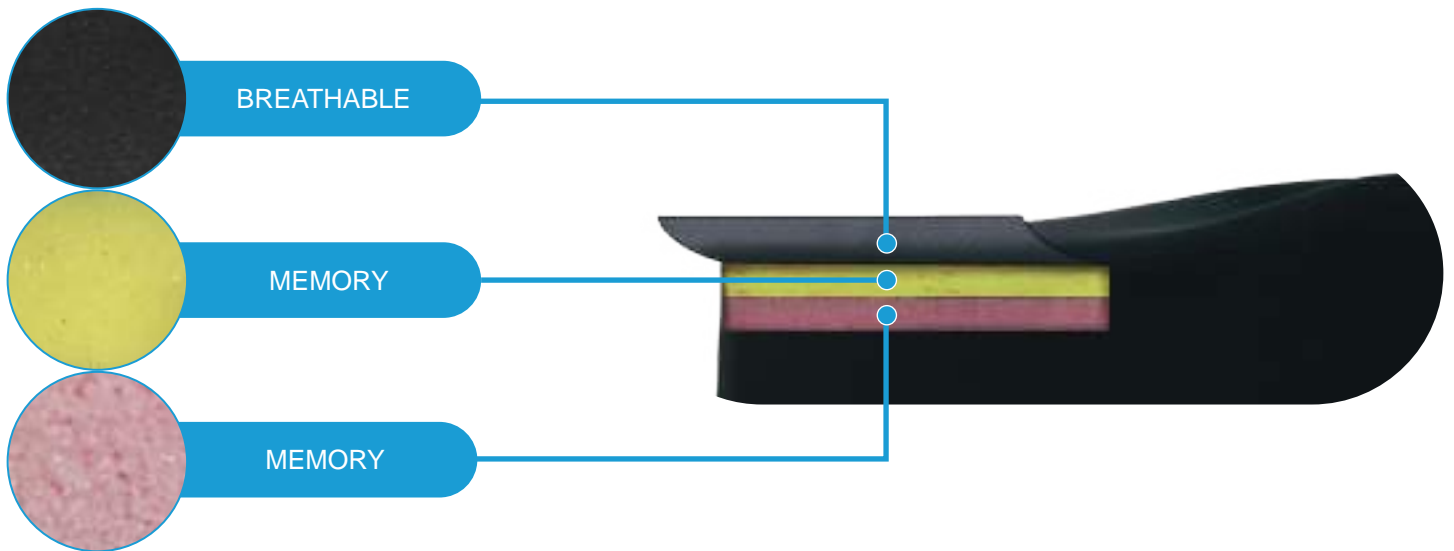

POSTURAL SEAT WITH FLAT BASE

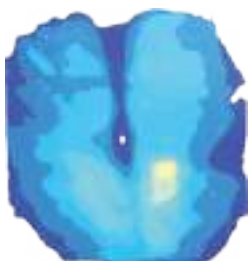



MODULAR INSERTS

PELVIC CONTAINING INSERTS

PELVIC CONTAINING AND LEG
ABDUCTION INSERTS



DEPTH REDUCTION INSERTS

ABDUCTOR AND ADDUCTOR
LEG INSERTS

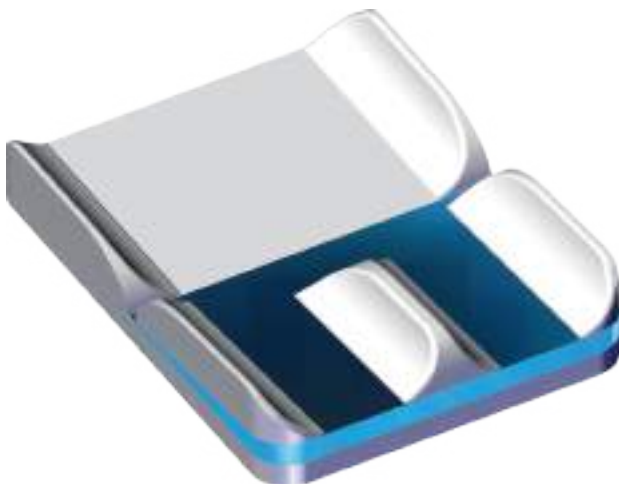

CLINICAL CASES AND PERSONALIZATION EXAMPLES

FIXED ABDUCTION

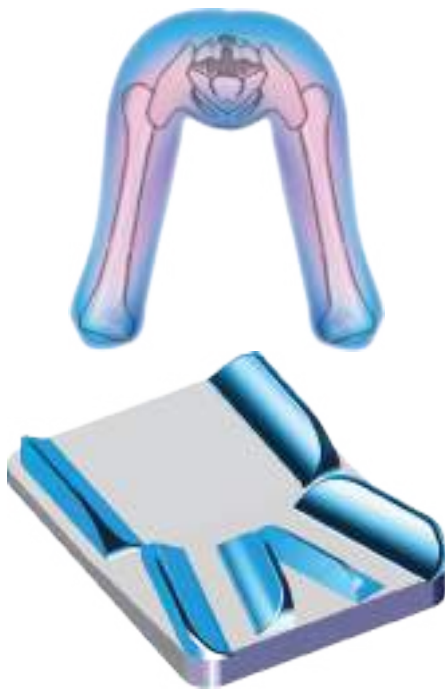

WIND SWEEP

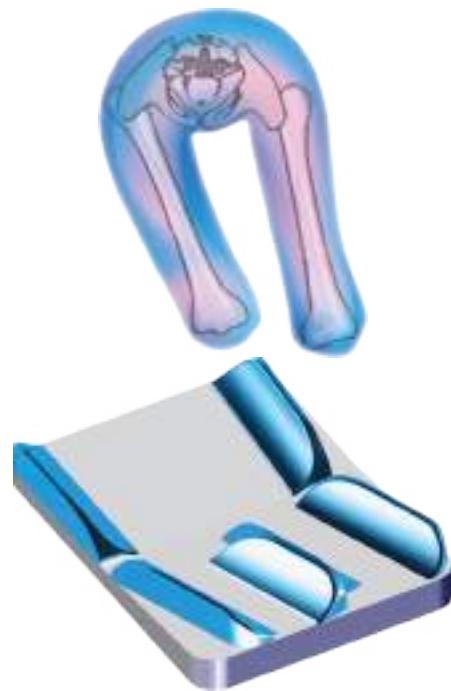

ASIMMETRY



PELVIC OBLIQUITY





BUDDY BRACE

BUDDY BRACE

Via A. De Curtis 4/a
80040 Cercola (NA) ITALIA

tel 081 555.19.46

fax 081 555.25.07

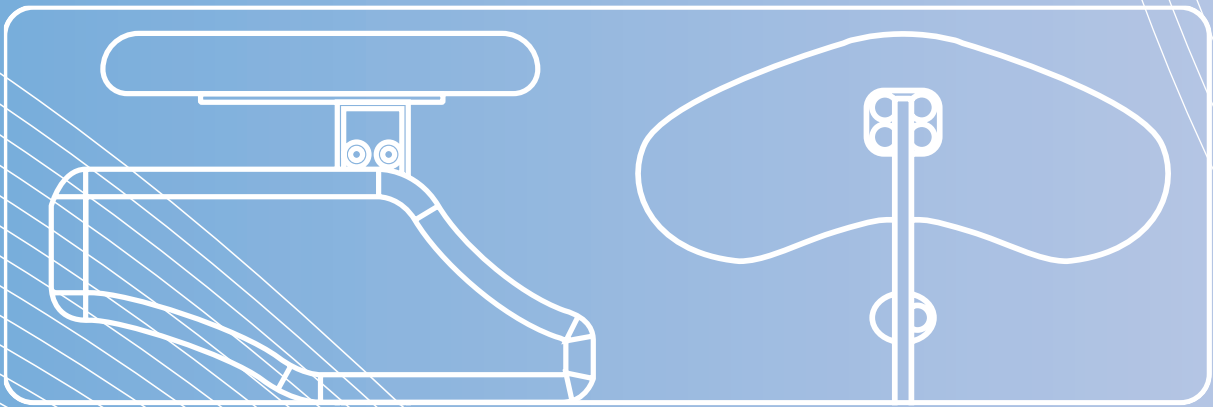
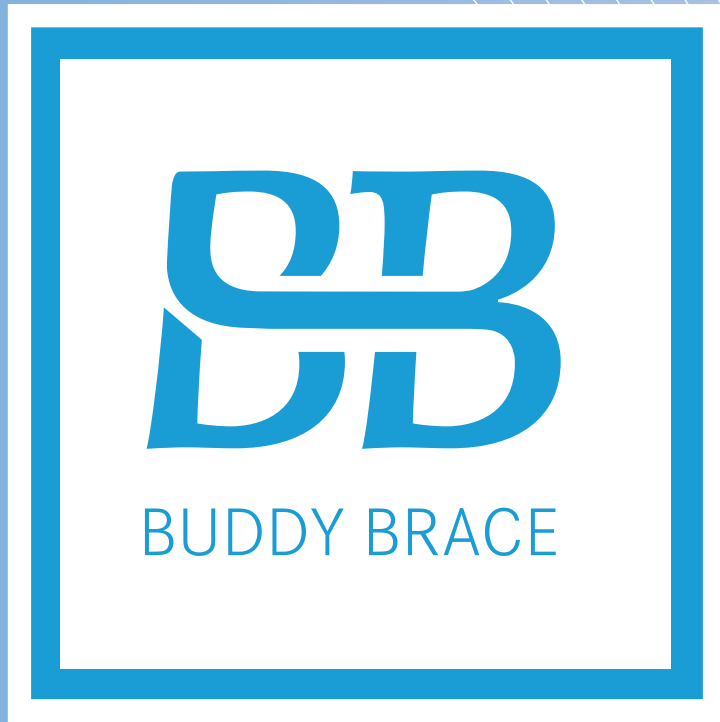

ACCESSORIES



BUDDY BRACE

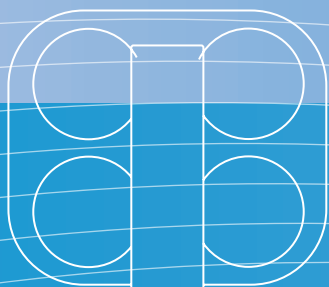

ACCESSORIES





HEADREST JOINING SYSTEM COMPATIBLE WITH MOST BACKRESTS ON THE MARKET

MOUNTING SYSTEMS



STANDARD MOUNTING PLATE

width	height	holes
9 cm	4,5 cm	M5

UNIVERSAL MOUNTING PLATE

width	height	holes
9 cm	11 cm	M6

HEADREST WITH ORBITAL MOVEMENT

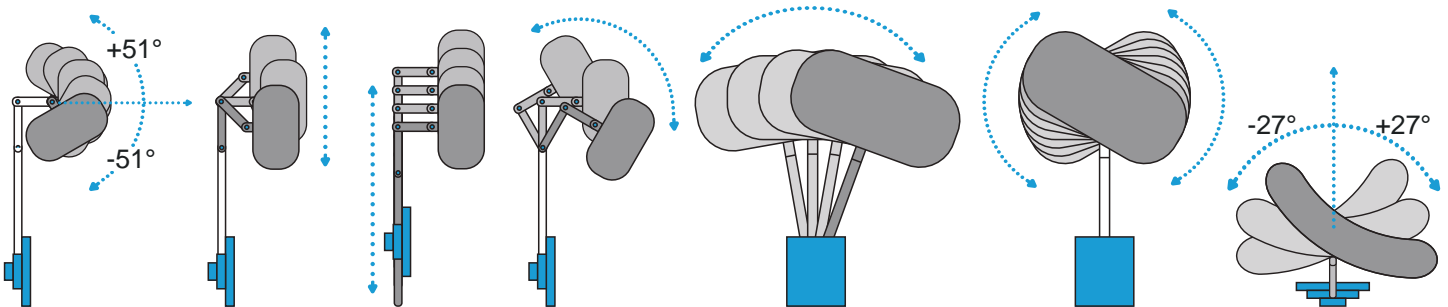

PADDING IN MEMORY FOAM WITH BREATHABLE AND REMOVABLE COVER

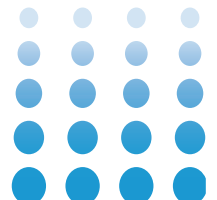
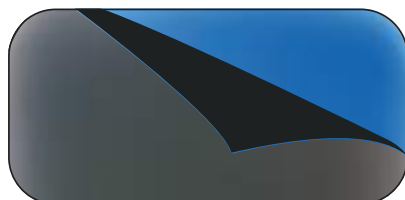

HEADREST PADS

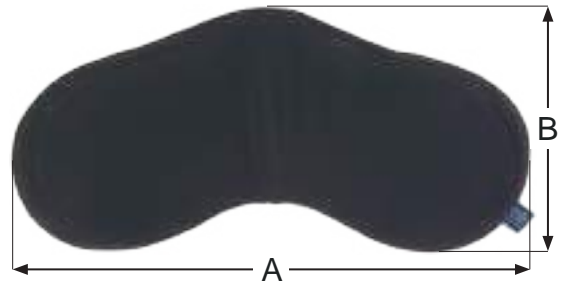
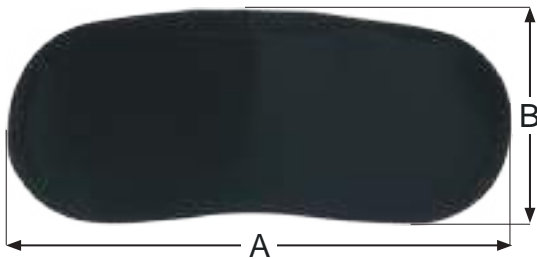

"O" PAD IN MEMORY			
	small	medium	large
A	23 cm	34 cm	42 cm
B	9 cm	16 cm	18 cm

"D" PAD IN MEMORY			
	small	medium	large
A	23 cm	34 cm	42 cm
B	12 cm	18 cm	22 cm

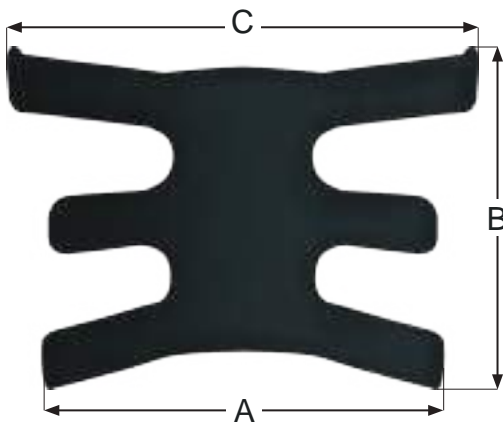

* "E" PAD			
	small	medium	large
A	15 cm	18 cm	26 cm
B	13 cm	16 cm	18 cm
C	18 cm	21 cm	22 cm

* "X" PAD		
	small	medium
A	20 cm	25 cm
B	17 cm	21 cm

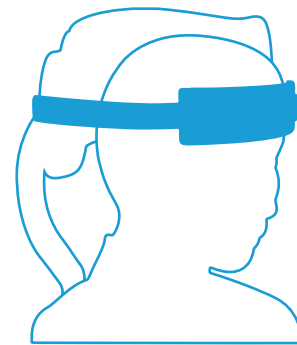
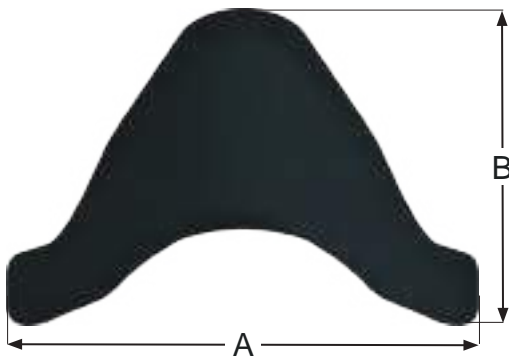

"A" PAD		
	small	medium
A	21 cm	26 cm
B	14 cm	17 cm

* COMPATIBLE WITH HEAD HOLDER

DOCKING SYSTEMS

"FREE-SHOCK" SYSTEM

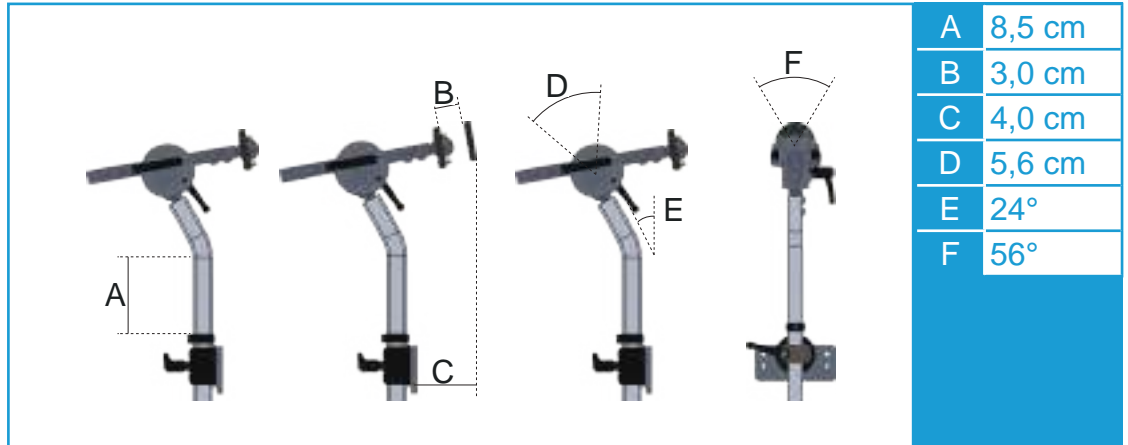

"I" SYSTEM

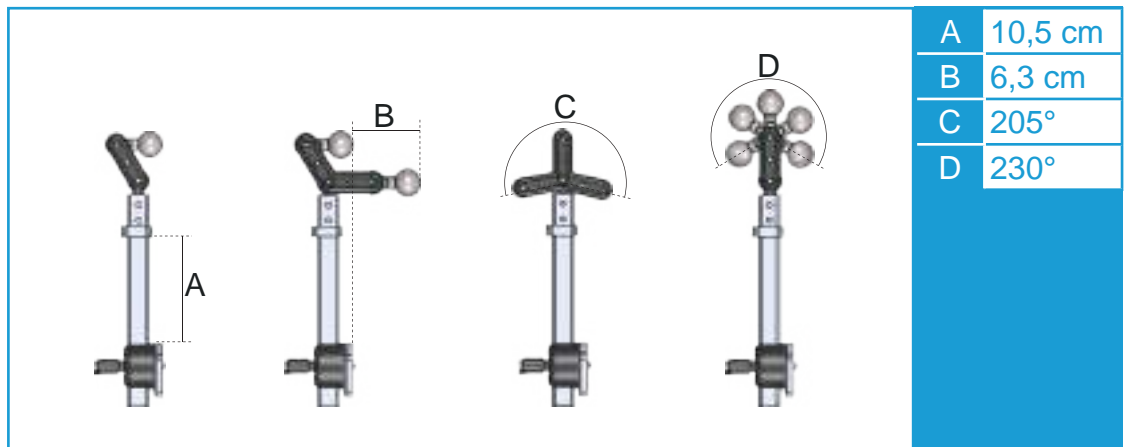

"C" SYSTEM

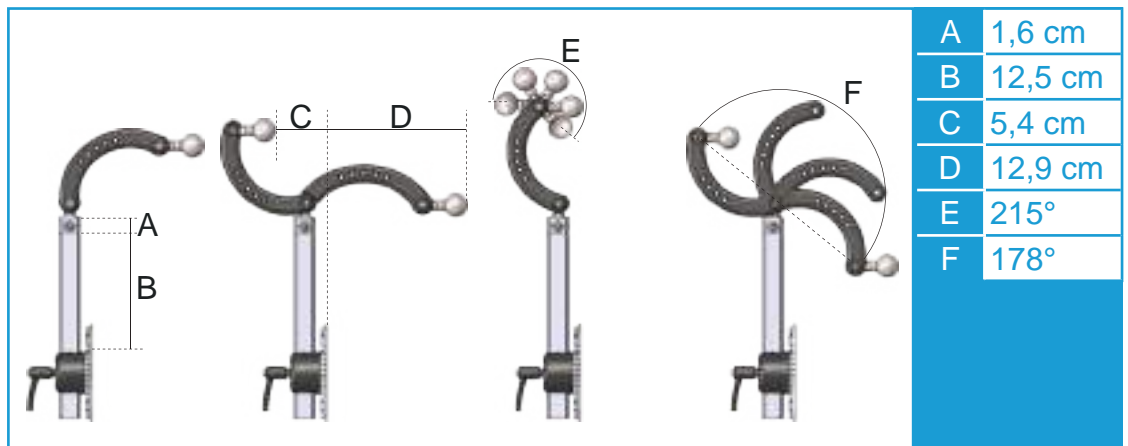

DOCKING SYSTEMS

"IC" SYSTEM

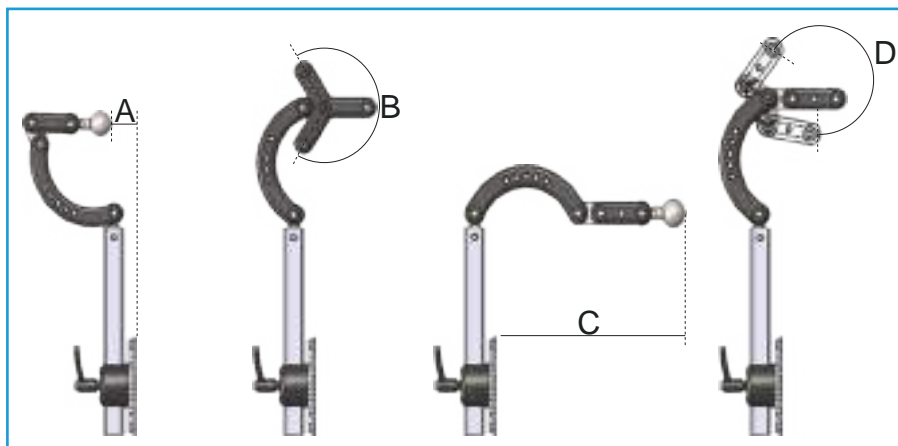

A	2,6 cm
B	242°
C	19,5 cm
D	244°

"CC" SYSTEM

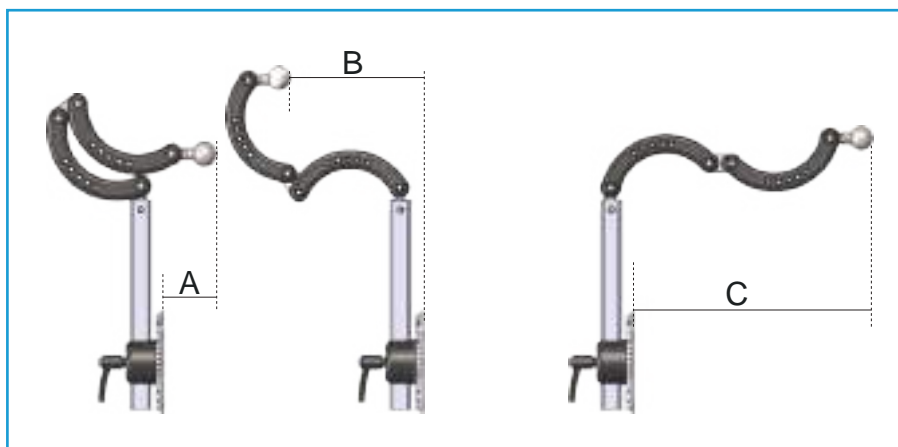

A	5,3 cm
B	13,8 cm
C	25,3 cm

"T" SYSTEM

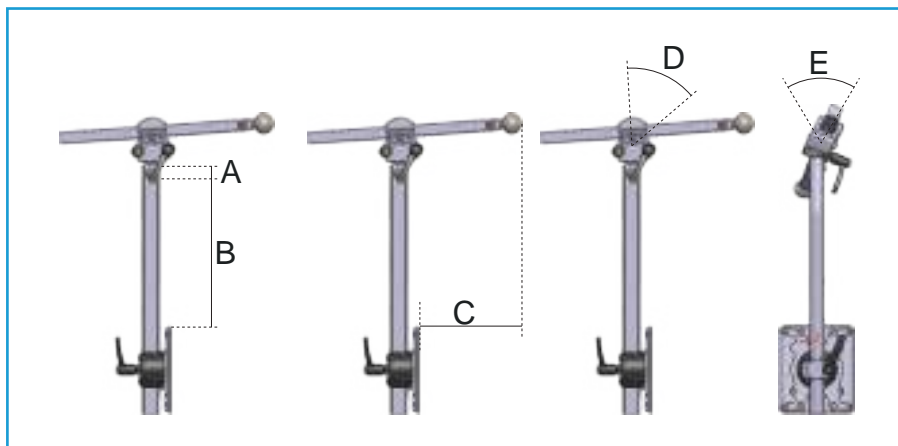

A	1,6 cm
B	12,5 cm
C	21,2 cm
D	56°
E	56°

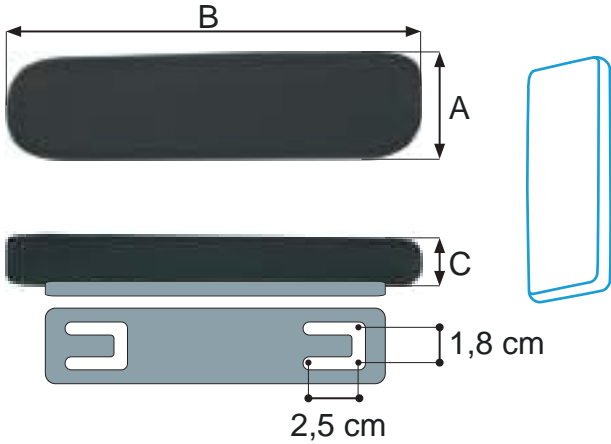

PADDED				
	XS	S	M	L
A	5 cm	7 cm	7 cm	11 cm
B	25 cm	30 cm	40 cm	35 cm
C	4 cm	4 cm	4 cm	4 cm

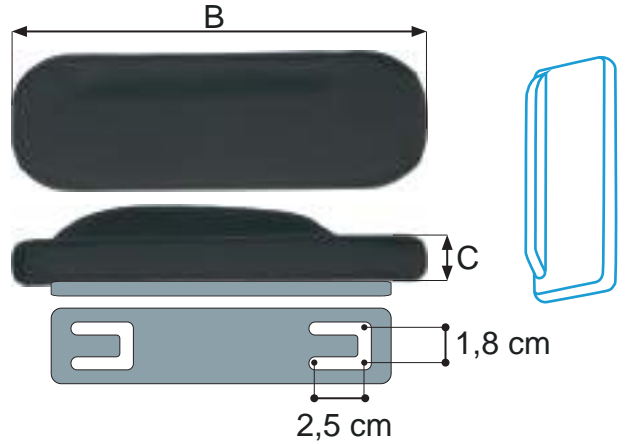

1 SIDE CONTOURING		
	S	L
A	9 cm	12 cm
B	30 cm	40 cm
C	6 cm	6 cm

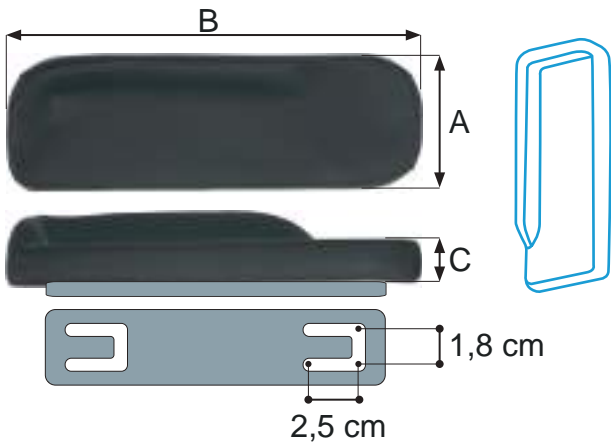

2 SIDES CONTOURING		
	S	L
A	9 cm	12 cm
B	30 cm	40 cm
C	5 cm	5 cm

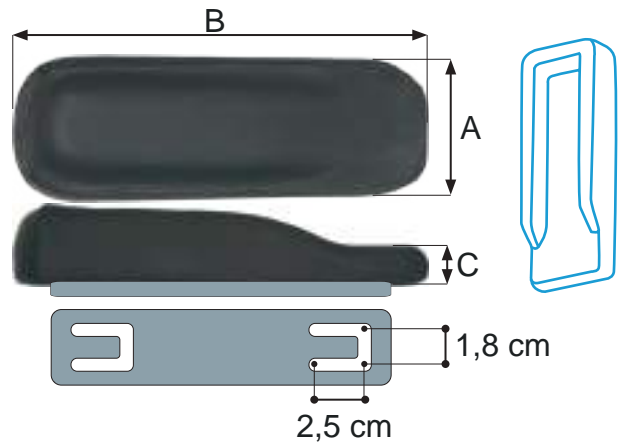

3 SIDES CONTOURING			
	S	M	L
A	9 cm	11,5 cm	13 cm
B	35 cm	35 cm	40 cm
C	5 cm	5 cm	5 cm

ARMREST SUPPORTS

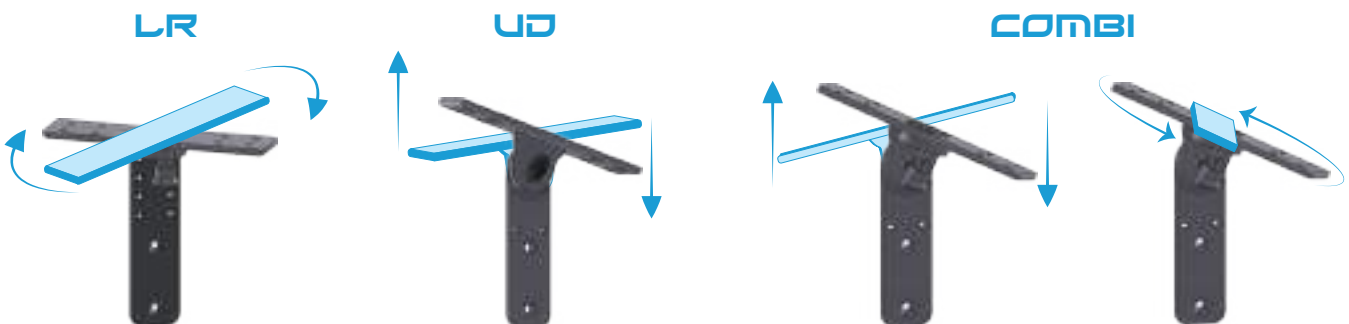

SUPPORT AIDS

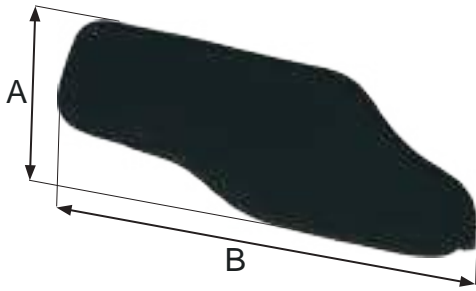

PADDED LATERAL SUPPORT		
	piccolo	grande
A	11 cm	13 cm
B	30 cm	35 cm
Thickness	3,5 cm	3,5 cm

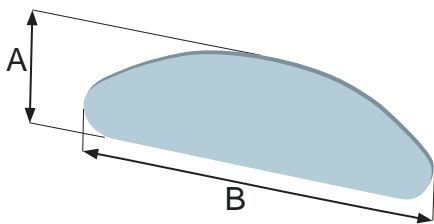

SMALL P.E.T.G. LATERAL SUPPORT	
A	9 cm
B	27 cm
Thickness with padding	2 cm

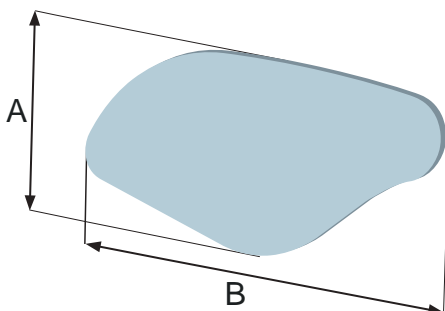
PADDED P.E.T.G. LATERAL SUPPORTS	
A	15 cm
B	31 cm
Thickness with padding	2 cm



ADJUSTABLE LEG SUPPORT WEDGE

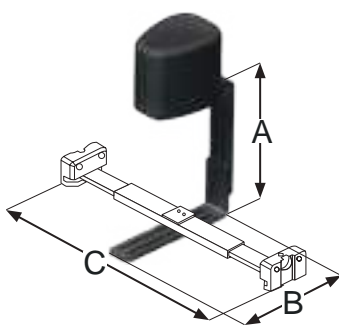

	small	large
A	11 cm	13 cm
B	30 cm	35 cm
C	3,5 cm	3,5 cm

REMOVABLE JOINT COVER

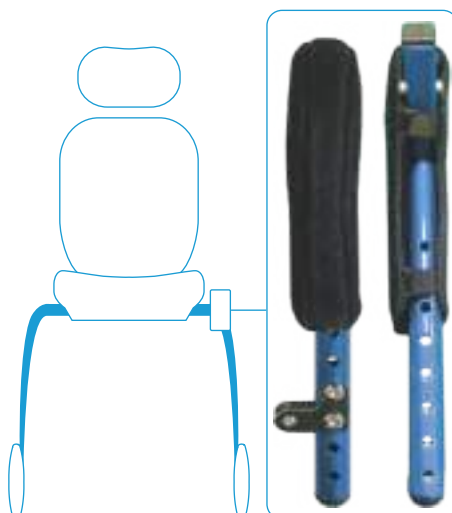

ADJUSTABLE LATERAL SUPPORT

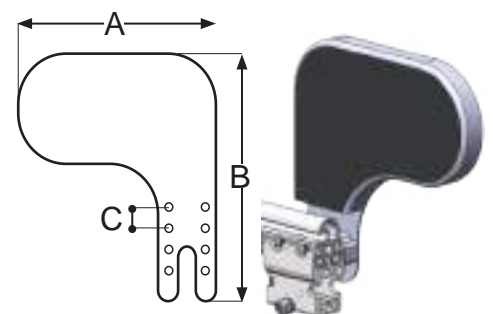

A	21 cm
B	26 cm
C	2 cm

P.E.T.G. TABLE

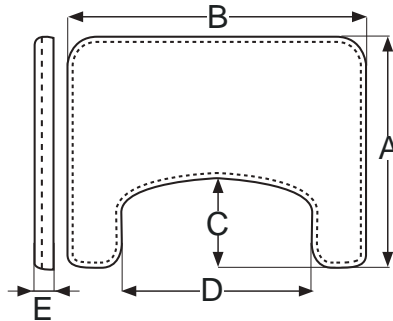
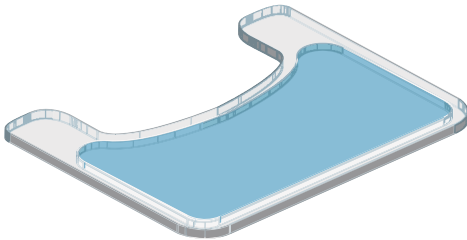

A	48 cm
B	62 cm
C	18,6 cm
D	39,5 cm
E	2 cm

P.E.T.G. SHAPED TABLE

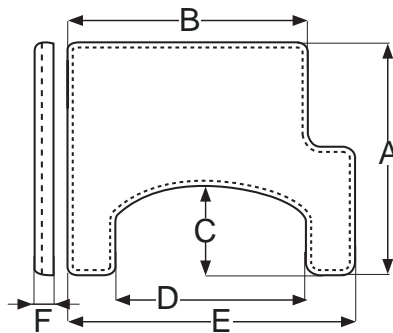
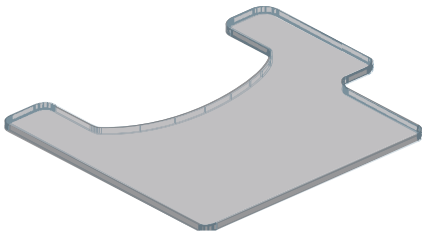

	small	large
A	41 cm	49 cm
B	42 cm	50 cm
C	16 cm	21 cm
D	33 cm	40 cm
E	50 cm	60 cm
F	0,8 cm	0,8 cm

LEATHERETTE PADDED TABLE

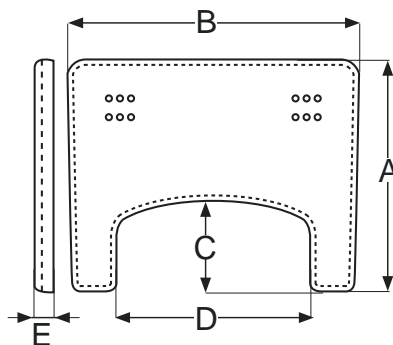

	small	medium	large
A	48 cm	48 cm	48 cm
B	60 cm	65 cm	70 cm
C	19 cm	19 cm	19 cm
D	40 cm	45 cm	50 cm
E	2 cm	2 cm	2 cm

MOUNTING SYSTEM

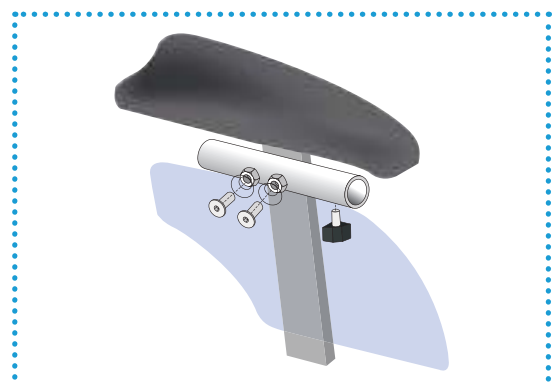
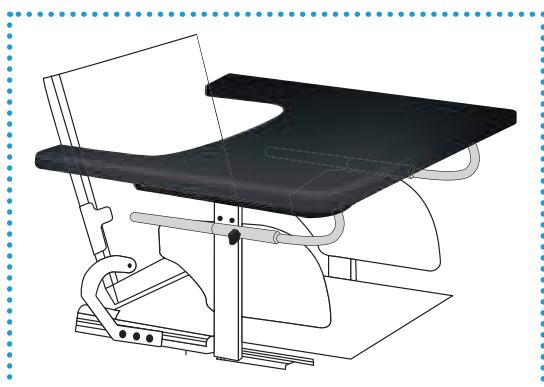



1 POCKET BAG			
	small	large	
width	28 cm	24 cm	
height	12 cm	12 cm	
depth	8 cm	8 cm	



SECRET BAG			
	small	large	
width	22 cm	30 cm	
height	18 cm	22 cm	
depth	3 cm	3 cm	



STRUCTURED BAG			
	small	large	
width	20 cm	30 cm	
height	18 cm	22 cm	
depth	10 cm	10 cm	



WATERPROOF SOFT BAG			
	small	large	
width	22 cm	26 cm	
height	12 cm	15 cm	
depth	12 cm	12 cm	



LEATHERETTE BAG			
	small	large	
width	30 cm	33 cm	
height	20 cm	22 cm	
depth	8 cm	8 cm	



BACKPACK AND RESPIRATOR BAG			
	small	large	
width	30 cm	40 cm	
height	29 cm	35 cm	
depth	15 cm	15 cm	



BUDDY BRACE

BUDDY BRACE

Via A. De Curtis 4/a
80040 Cercola (NA) ITALIA

tel 081 555.19.46

fax 081 555.25.07

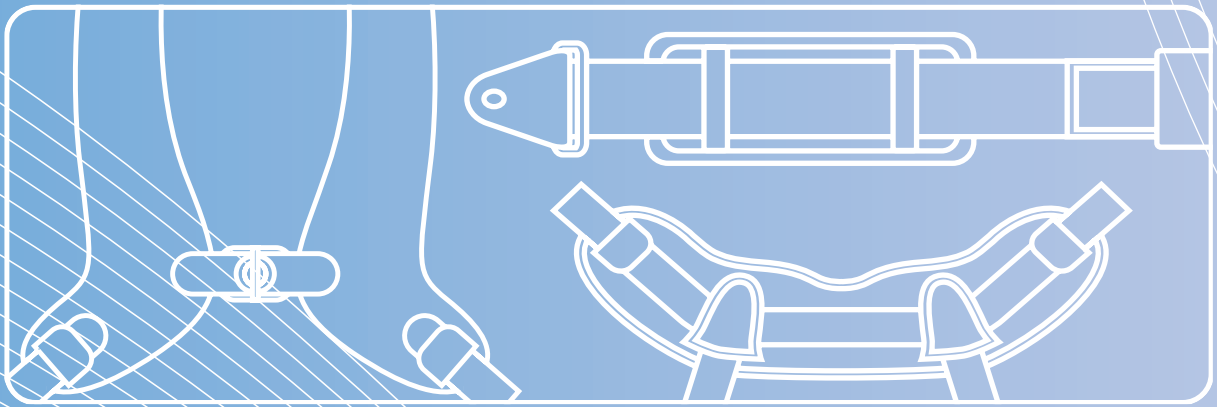
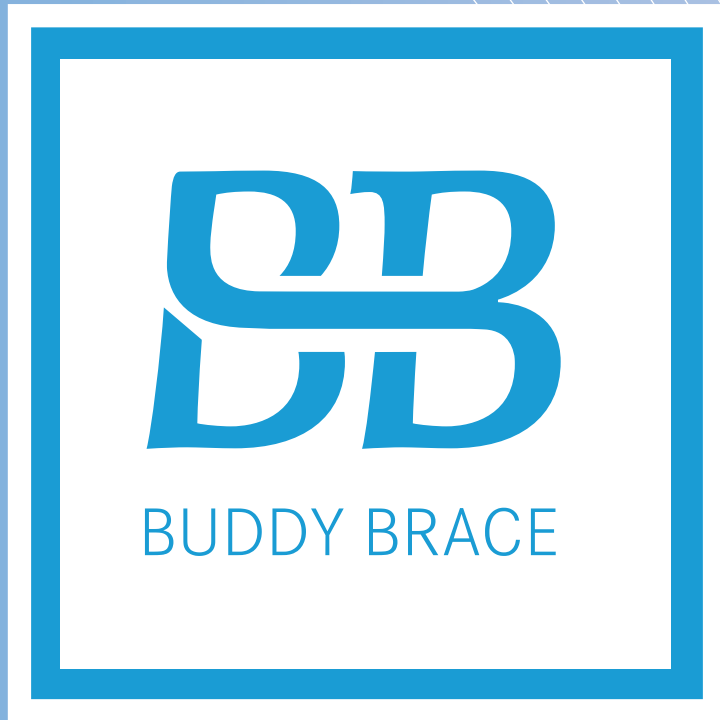

HARNESSES



BUDDY BRACE





HARNESSES



HEAD HOLDER

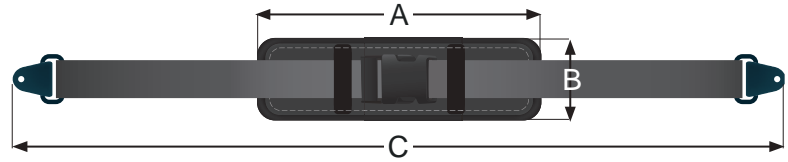

	small	large
A	15 cm	20 cm
B	5 cm	5 cm
C	40 - 45 cm	45 - 50 cm

CHEST BELTS

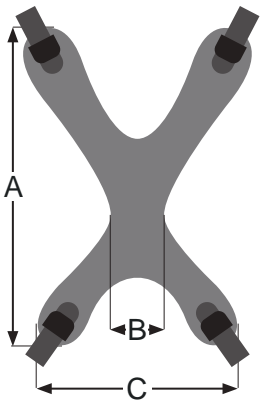

BUTTERFLY X

	small	medium	large
A	31 cm	41 cm	51 cm
B	5 cm	6 cm	7 cm
C	27 cm	29 cm	37 cm

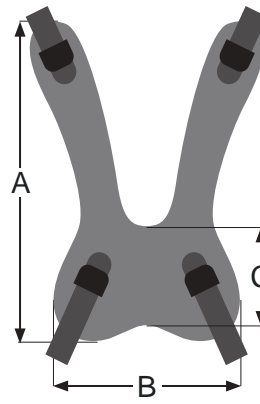

BUTTERFLY U

	small	medium	large
A	31 cm	41 cm	51 cm
B	21 cm	28 cm	36 cm
C	8 cm	10 cm	12 cm

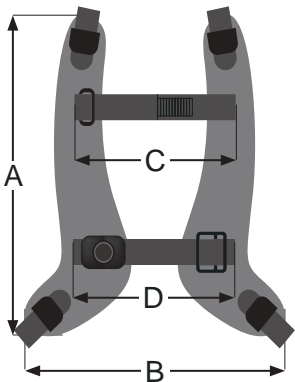

BUTTERFLY H

	small	medium	large
A	31 cm	41 cm	51 cm
B min	23 cm	27 cm	35 cm
B max	31 cm	39 cm	51 cm
C strap	18 cm	28 cm	38 cm
D strap	20 cm	25 cm	30 cm

MOUNTING SYSTEM

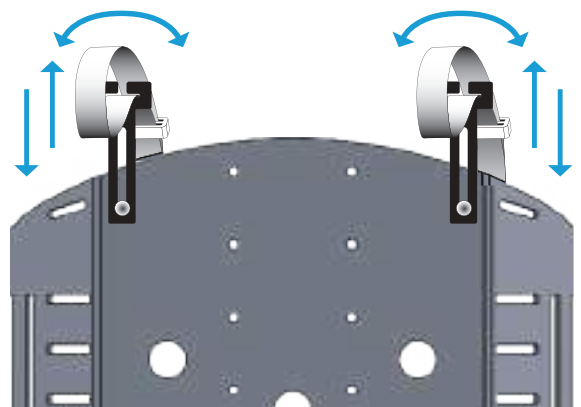

PELVIC BELTS WITH 2 FASTENING POINTS

METALLIC BUCKLE

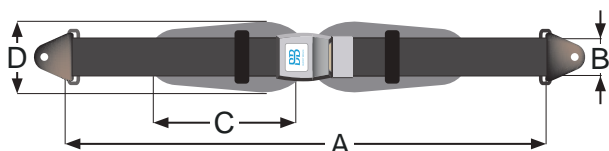

	small	large
A	130 - 140 cm	150 - 160 cm
B	2,5 cm	4 cm
C	20 cm	25 cm
D	4 cm	8 cm

PLASTIC BUCKLE

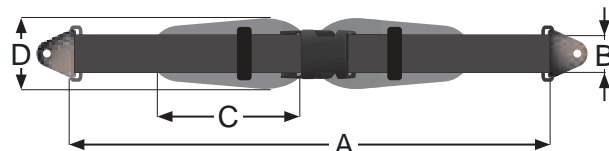

	small	large
A	130 - 140 cm	150 - 160 cm
B	2,5 cm	4 cm
C	20 cm	25 cm
D	4 cm	8 cm

PELVIC BELTS WITH 4 FASTENING POINTS

METALLIC BUCKLE

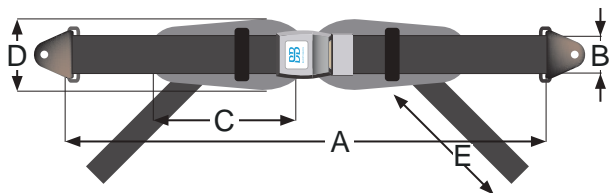

	small	large
A	130 - 140 cm	150 - 160 cm
B	2,5 cm	4 cm
C	20 cm	25 cm
D	4 cm	8 cm
E	80 cm	80 cm

PLASTIC BUCKLE

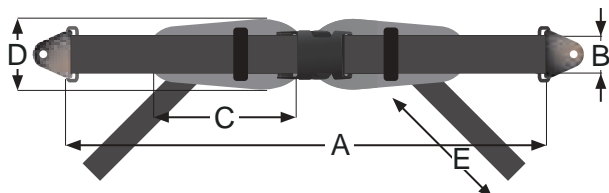

	small	large
A	130 - 140 cm	150 - 160 cm
B	2,5 cm	4 cm
C	20 cm	25 cm
D	4 cm	8 cm
E	80 cm	80 cm



HARNESS

ARM HOLDER

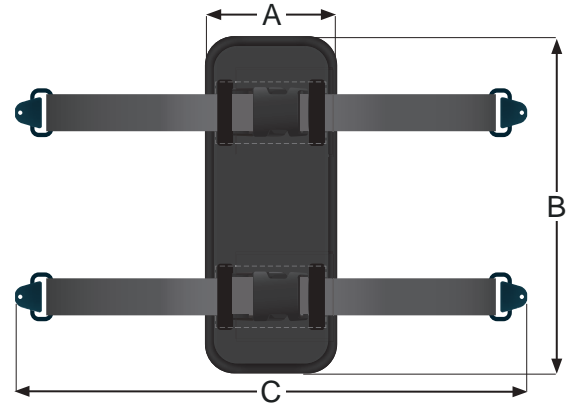

	small	large
A	15 cm	20 cm
B	7 cm	10 cm
D	25 - 30 cm	30 - 35 cm

CALF SUPPORTS

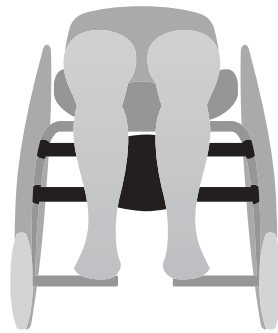

SMALL

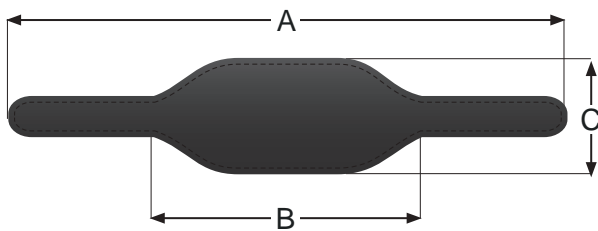

	small
A	80 cm
B	36 cm
D	19 cm

MEDIUM/LARGE

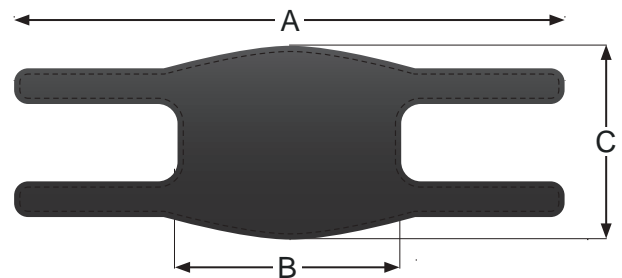

	medium	large
A	90 cm	100 cm
B	41 cm	40 cm
D	21 cm	23 cm

ANKLETS

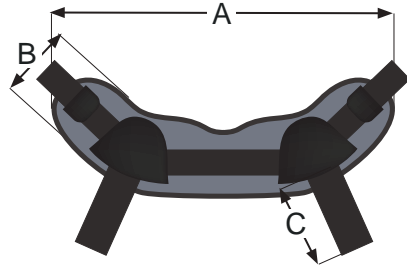
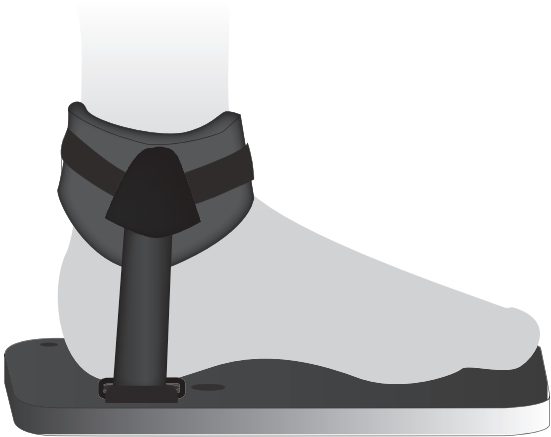

	small	medium	large
A	23 - 28 cm	27 - 34 cm	29 - 38 cm
B	6,5 cm	6,5 cm	6,5 cm
C	15 cm	18 cm	20 cm

FEET STRAPS

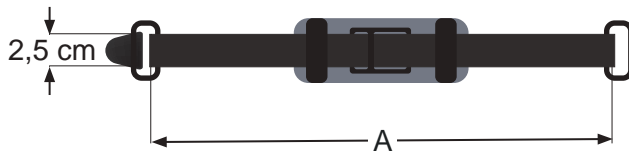
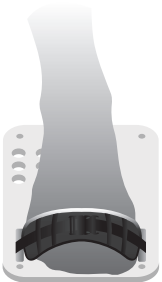

one foot system			
	small	medium	large
C	12 - 16 cm	15 - 19 cm	18 - 22 cm

two feet system			
	small	medium	large
C	25 - 29 cm	30 - 34 cm	35 - 39 cm

HEEL STRAPS

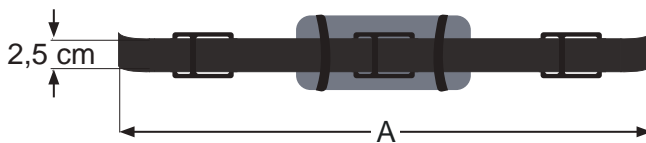

one foot system	
A	30 cm

two feet system	
A	60 cm



BUDDY BRACE

BUDDY BRACE

Via A. De Curtis 4/a
80040 Cercola (NA) ITALIA

tel 081 555.19.46

fax 081 555.25.07

One²One

designed^{for} you

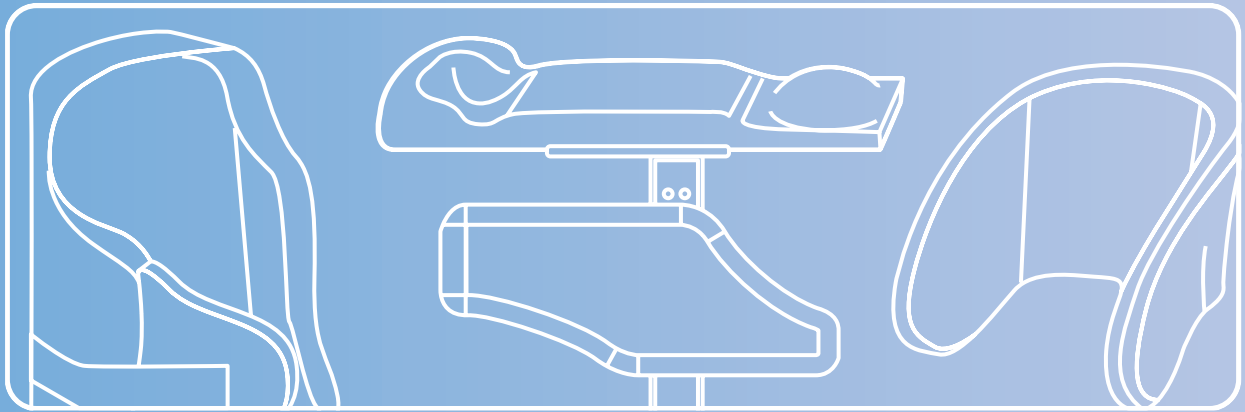

3D SCAN SYSTEMS

CLOUD POSTURAL SYSTEM



- 1 Postural seating system entirely customizable
- 2 The seat is designed one by one and the cover is tailor-made
- 3 Customizable, breathable and washable cover

CLOUD+ POSTURAL SYSTEM



- 1 3D scanned postural system with lateral swing away containments
- 2 Very comfortable and easy lateral transfer
- 3 Structure, frame and cover completely customizable

CUSTOMIZABLE COVERS AND PADDINGS

AIRMESH 3D COVERS WITH DIFFERENT COLORS

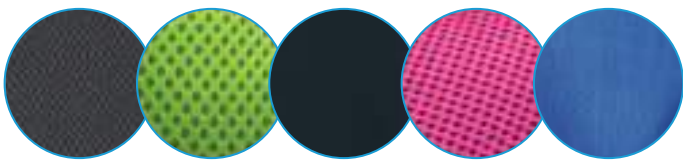

PADDINGS IN P.U. WITH DIFFERENT LEVELS OF DENSITY

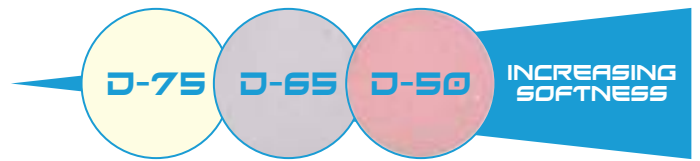

CUSTOMIZABLE FRAME WITH COLOURS AND ACCESSORIES

16 COLORS AVAILABLE

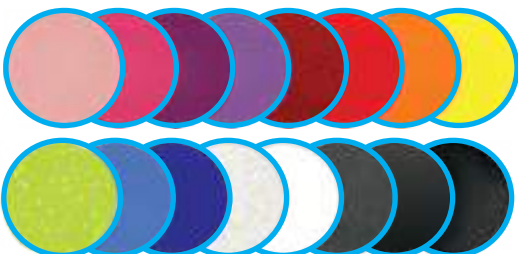

MOUNTING SYSTEM



TYPE OF POSTURES



BACK



SEAT



BACK SEAT

ARMREST AND HEADREST



STRETCHER



1
2
3

3D scanned accessories

Customizable covers for every needs

Customizable paddings for every comfort

1
2
3

3D scanned lay down seating for structurized users

Modular frame to fix to a wheelchair or a base

Customizable covers and paddings

CUSTOMIZABLE COVERS

AIRMESH

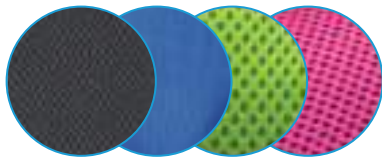

LEATHERETTE

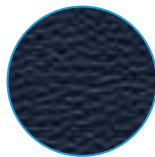

TWO-WAY STRETCH

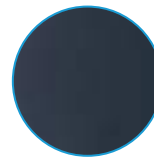

WATERPROOF



CUSTOMIZABLE PADDINGS

BREATHABLE



MEMORY

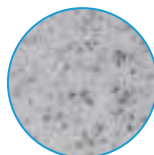

P.E.

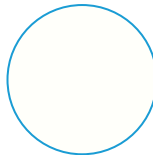

P.D. WITH DIFFERENT DENSITIES





BEK HYBRID

BACKRESTS

Covers	User weight	Backrest width	Backrest height	Warranty	Crash tested	Certificates	Fire resistant
Seamless and breathable	Max 150 kg	← cm → from 26 to 54	↑ cm ↓ from 30 to 55	2 years	On manual and powered wheelchairs	CE	TÜV Rheinland Accredited Laboratory



- For people with severe deformities which need lateral support
- The backrest is designed one by one and the cover is tailor-made
- Customizable padding with breathable and washable cover

SIZES AND MOUNTING SYSTEMS

Bek	Wheelchair width	Backrest width (A)	Backrest height (B)
	width	26 cm (M0)	30 cm
	26 - 30 cm	30 cm (M1)	35 cm - 40 cm
	30 - 34 cm	34 cm (M2)	40 cm - 45 cm
	34 - 38 cm	38 cm (M3)	45 cm - 50 cm
	38 - 42 cm	42 cm (M4)	45 cm - 50 cm - 55 cm
	42 - 46 cm	46 cm (M5)	45 cm - 50 cm - 55 cm
	46 - 50 cm	50 cm (M6)	55 cm
	48 - 52 cm	54 cm (M7)	50 cm

ADJUSTABLE SEPARATE CLAMPS

ADJUSTABLE UNIQUE CLAMPS

● 2 cm
● 2,2 cm
● 2,5 cm

COVERS WITH DIFFERENT COLOURS AND MATERIALS

AIRMESH

BREATHABLE SOFT ELASTIC

LEATHERETTE

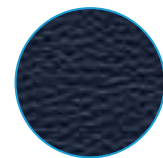
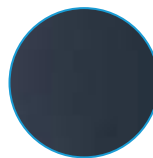
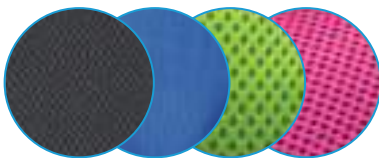

PADDING IN P.D. WITH DIFFERENT LEVELS OF DENSITY

D-75

D-65

D-50

INCREASING
SOFTNESS

SUPPORT

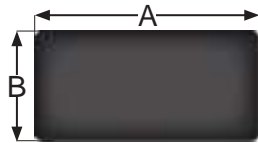

PAD SIZES			
	S	M	L
A	11,0 cm	14,0 cm	18,0 cm
B	9,0 cm	10,0 cm	12,0 cm

HUG

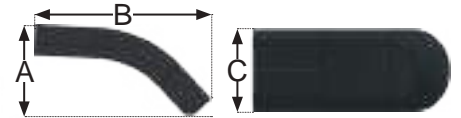

PAD SIZES			
	S	M	L
A	5,5 cm	10,0 cm	10,0 cm
B	12,0 cm	18,0 cm	24,0 cm
C	9,0 cm	9,0 cm	10,0 cm

CONTOUR

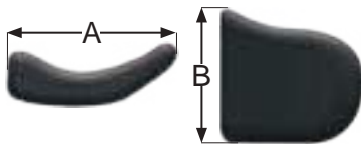

PAD SIZES			
	S	M	L
A	11,0 cm	15,0 cm	20,0 cm
B	8,0 cm	15,0 cm	20,0 cm

HOLD UP

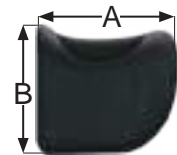

PAD SIZES			
	S	M	L
A	12,0 cm	16,0 cm	21,0 cm
B	9,0 cm	16,0 cm	21,0 cm

FIXING SYSTEMS

FIXED

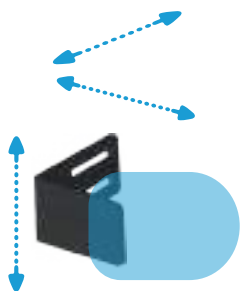

← ADJUSTMENTS →

SWING-AWAY

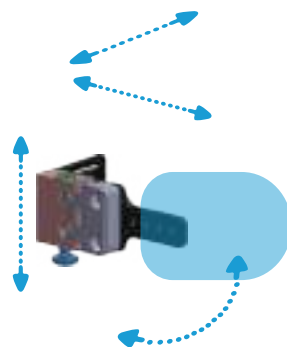

← ADJUSTMENTS →

DETACHABLE

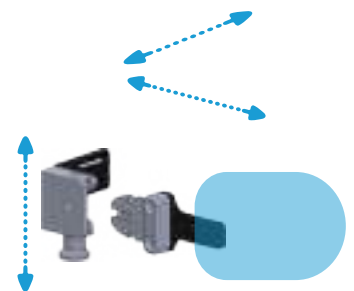

← ADJUSTMENTS →

BEK HYBRID PLUS



1

Even the sides support are 100% customized

2

Choice of different kind of brackets for lateral supports

3

Cover and padding are customizable and removable

FIXING SYSTEMS

3D SCANNED PADS

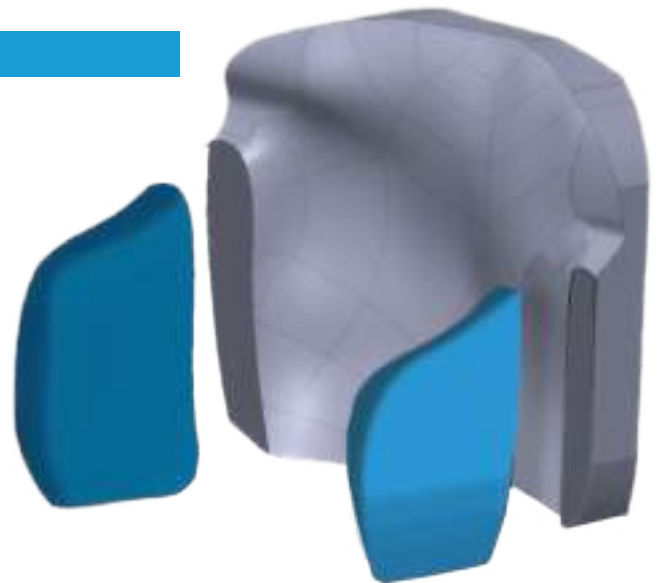

FIXED

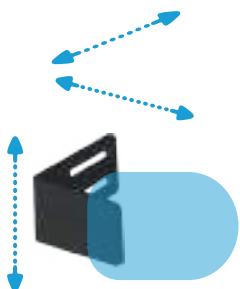

SWING-AWAY

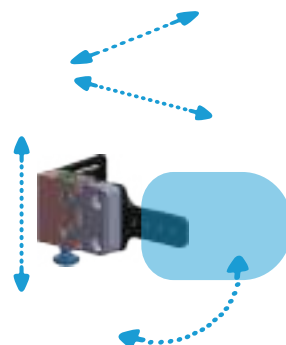

DETACHABLE

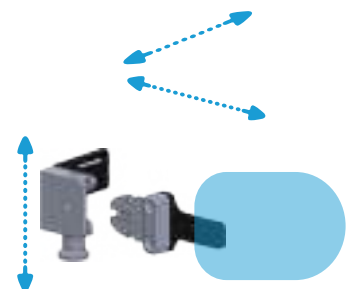

MODULAR WHEELCHAIR FOR THE POSTURAL ELEMENTS CONFIGURATION



- 1 Allows the configuration of the Buddy Brace and One2One postural products based on the user's anthropometric measurements
- 2 Designed to accommodate Vakuu Buddy Brace bags for 3D scanning of the user's body (trunk - pelvis)
- 3 It allows the creation of extremely comfortable ergonomic postural systems for a significant improvement in the quality of life



PRODUCTION PHASES FOR THE CREATION OF POSTURAL SYSTEMS BASED ON 3D SCANNING

1. SCAN



2. DESIGN PROCESS OF THE SEATING SYSTEM

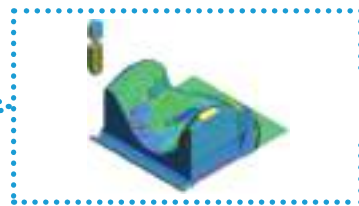

3. POSTURE



4. FRAME



5. CUSTOM COVER



One²One

designed^{for} you

BUDDY BRACE

Via A. De Curtis 4/a
80040 Cercola (NA) ITALIA

tel 081 555.19.46

fax 081 555.25.07

One²One

designed^{for} you

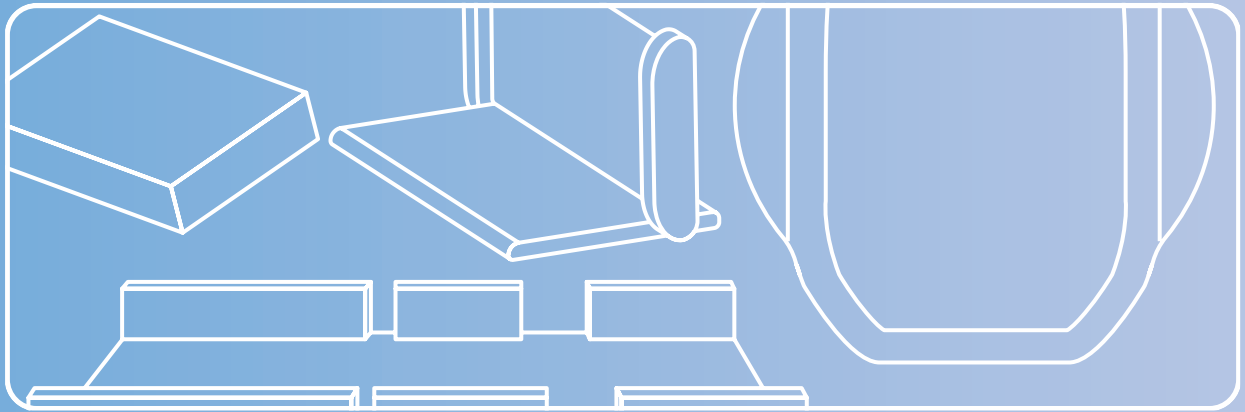

CUSTOMIZED SYSTEMS



BACKREST IN MEMORY

Covers	User weight	Backrest width	Backrest height	Warranty	Crash tested	Certificates	Fire resistant
Seamless and breathable	Max 150 kg	from 26 to 54	from 30 to 55	2 years	On manual and powered wheelchairs	CE	TÜV Rheinland Accredited Laboratory



- 1 Backrest for light postural deformities
- 2 Backrest in memory highly adjustable and customizable
- 3 Freedom of movement with adjustable side support

COVER WITH DIFFERENT MATERIALS AND COLOURS

BREATHABLE 3D AIRMESH

LEATHERETTE

BREATHABLE SOFT ELASTIC

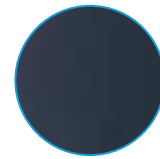
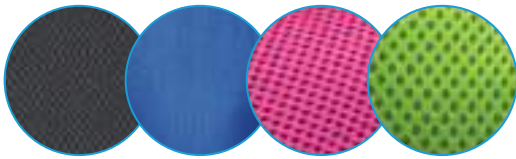

PADDING IN MEMORY FOR LIGHT DEFORMITIES

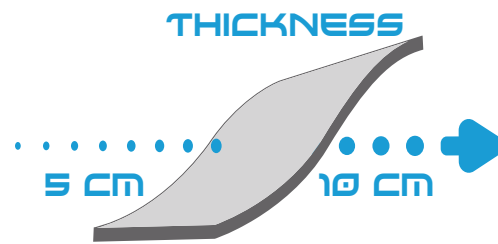
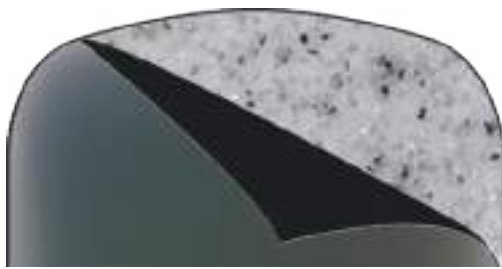

SIZES AND MOUNTING SYSTEMS

Bek	Wheelchair width	Backrest width (A)	Backrest height (B)
	width	26 cm (M0)	30 cm
	26 - 30 cm	30 cm (M1)	35 cm - 40 cm
	30 - 34 cm	34 cm (M2)	40 cm - 45 cm
	34 - 38 cm	38 cm (M3)	45 cm - 50 cm
	38 - 42 cm	42 cm (M4)	45 cm - 50 cm - 55 cm
	42 - 46 cm	46 cm (M5)	45 cm - 50 cm - 55 cm
	46 - 50 cm	50 cm (M6)	55 cm

ADJUSTABLE SEPARATE CLAMPS

ADJUSTABLE UNIQUE CLAMPS

● 2 cm
● 2,2 cm
● 2,5 cm

COMPATIBLE BB LATERAL SUPPORTS



SUPPORT

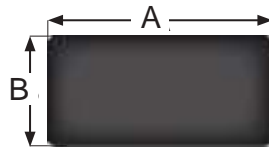

PAD SIZES

	S	M	L
A	11,0 cm	14,0 cm	18,0 cm
B	9,0 cm	10,0 cm	12,0 cm



HUG

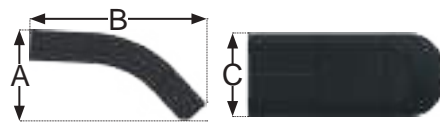

PAD SIZES

	S	M	L
A	5,5 cm	10,0 cm	10,0 cm
B	12,0 cm	18,0 cm	24,0 cm
C	9,0 cm	9,0 cm	10,0 cm

FIXING SYSTEMS

FIXED

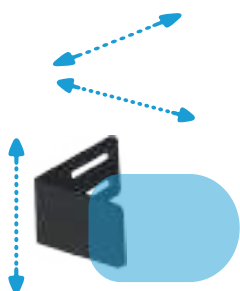

← ADJUSTMENTS →

SWING-AWAY

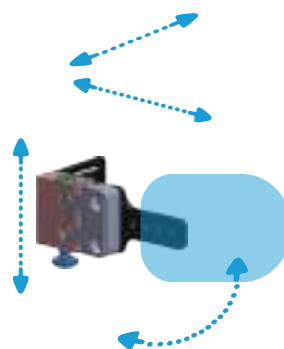

← ADJUSTMENTS →

DETACHABLE

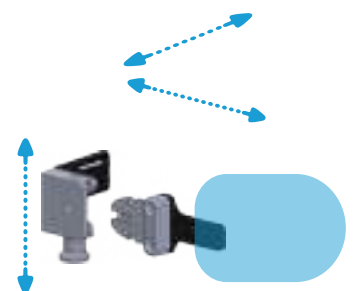

← ADJUSTMENTS →



BACKREST IN MEMORY

COMPATIBLE BB LATERAL SUPPORTS



CONTOUR

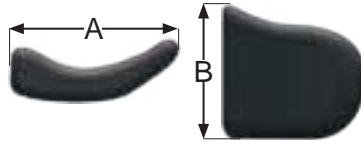

PAD SIZES

	S	M	L
A	11,0 cm	15,0 cm	20,0 cm
B	8,0 cm	15,0 cm	20,0 cm

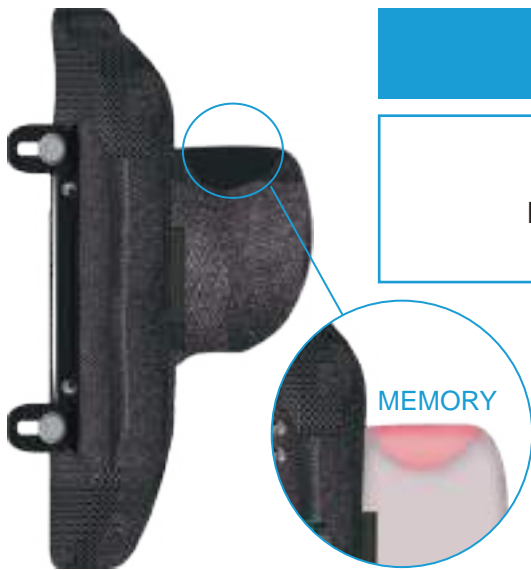

HOLD UP

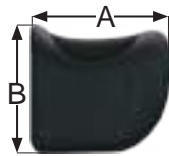

PAD SIZES

	S	M	L
A	12,0 cm	16,0 cm	21,0 cm
B	9,0 cm	16,0 cm	21,0 cm

FIXING SYSTEMS

FISSO

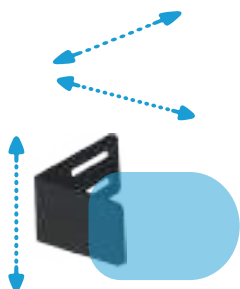

← ADJUSTMENTS →

SWING-AWAY

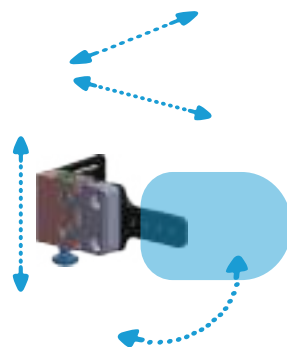

← ADJUSTMENTS →

DETACHABLE

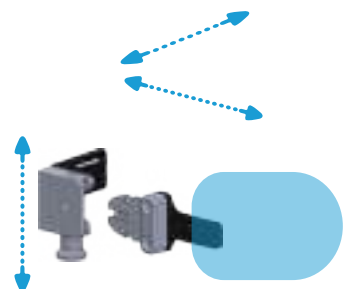

← ADJUSTMENTS →



1

Postural seating system designed to satisfy the needs of users in tender age

2

Structural seating system designed to control and correct the posture in the tender age

3

With rigid internal base and soft, customizable, breathable and removable textile

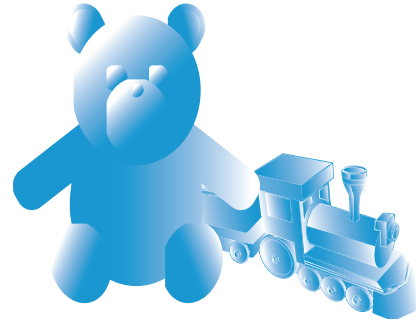

CUSTOMIZABLE PADDINGS

AIRMESH

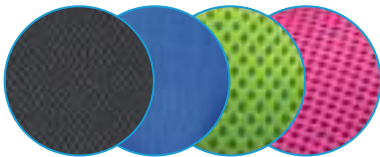

LEATHERETTE

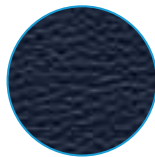

TWO-WAY STRETCH

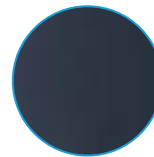

WATERPROOF



PADDING



P.E.

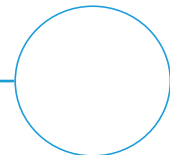



- 1 Toddler positioning system with flat base
- 2 Customizable and adaptable to different models of positioning system
- 3 Soft and customizable, breathable and removable textile

CUSTOMIZABLE COVERS

AIRMESH

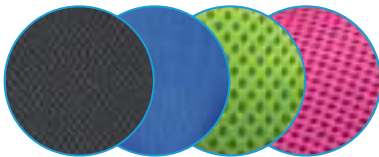

LEATHERETTE

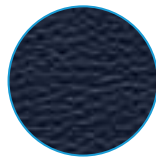

TWO-WAY STRETCH

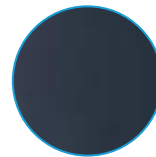

WATERPROOF



CUSTOMIZABLE PADDINGS

BREATHABLE



MEMORY

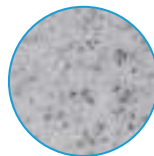

P.E.

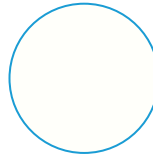

P.U. WITH DIFFERENT LEVELS OF DENSITY

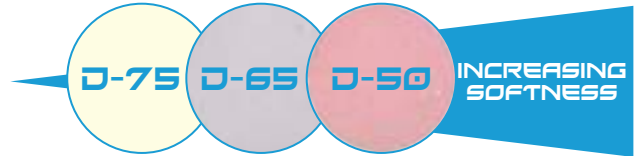

HUGGIE AQUA POSTURAL SYSTEM



- 1 Rigid but lightweighted and tailored positioning system
- 2 Suitable for the sea, the pool and for user bathing in the tender age
- 3 Positioning suitable for all outdoor activities being waterproof



CUSTOMIZABLE ACCESSORIES

STRETCHER

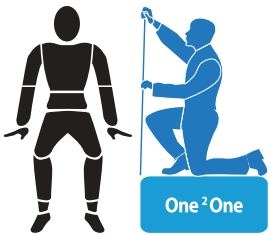

STRUCTURED PADDED LEGREST

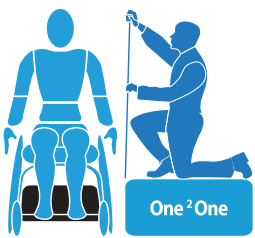

ADJUSTABLE PADDED LEGREST

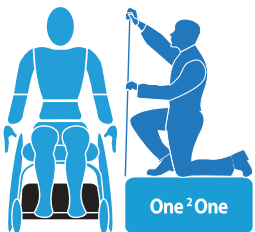

One²One

designed^{for} you

BUDDY BRACE

Via A. De Curtis 4/a
80040 Cercola (NA) ITALIA

tel 081 555.19.46

fax 081 555.25.07